

SLABBINCK®

2024



SLABBINCK®

At Slabbinck we constantly strive to increase your sales and our service. In this technical brochure you will find great sales advice, information on marketing tools, many technical specifications and answers to questions that customers may have.

This brochure is a handbook with information that will help you to understand our products even better. This tool will give you the information you need to be able to reply immediately to most of your customers' questions, increasing your service level for our collection.

We do thank you for your continuous support and look forward to our business together.



Mirabel Slabbinck



Viktor Slabbinck



Slabbinck Design Studio



Please contact us for your special project. Together, we create starting from a sketch up to a finished product.

Techniques: basic fabrics

We offer many plain fabrics and fabrics with woven designs. They come in a wide variety of material and weight. These fabrics do not require embroidery or application, but ornamenting techniques are possible on these fabrics.

The Pius fabric is very popular for lower budget paraments and lightweight vestments. The Pius fabric can also be combined with the Elias fabric, which is used for the Assisi collection.

The Linus fabric is also a very nice lightweight fabric, with gold and coloured lines.

The Dupion fabric is somewhat heavier and comes in many different colours, it is therefore a great alternative for customers who are looking for flexible options.

The Melchior fabric is known in association with Pope Jean-Paul II, who loved wearing a vestment in this fabric on several occasions.

Brugia is the only fabric that is made of 100% wool. Wool breaths very well, but it is somewhat more difficult in maintenance.

Most of our fabrics therefore are a mix of natural and man-made fibres. This guarantees an easy care approach, while maintaining the beauty of the natural fibres.



Pius



Linus - 5375



Dupion



Melchior



Brugia

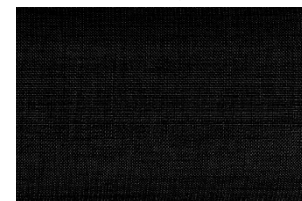

Techniques: machine embroidery

We have three unique embroidery machines in our workshop. Two of them are unique in Europe because of their large embroidery field, enabling us to embroider almost the entire shape of a chasuble, up to 145 cm (57") x 145 (57") cm, in one run. The advantage of machine embroidery is the speed of embroidery and the ability to embroider small details.

The punchcards are always made in-house. This allows us to be very flexible and to focus on the quality of the embroidery at all times.

Machine embroidery is perfect for larger series of paraments with the same design and for smaller and/or detailed designs. Because of the need of a punchcard that needs to be programmed by our embroidery expert, large designs are not budget friendly in this technique due to the many hours needed to make the punchcard. We recommend the application technique for large designs.



Techniques: application

This technique is probably most related to Slabbinck since the 1970's. It is a great technique allowing us to make large designs easily. Once the design is made and printed on our plotting machine, the pieces of fabric used for the design are cut out by hand in our workshop. Just like a mosaic, the pieces of fabric are put together to create the design. The application is finished with embroidery, so that the feel and look of the design is that of an embroidered piece.

It is not possible to work very detailed with the application technique, but larger designs are easily made. Since it is all done by hand, one single piece can be finished in this technique. We mainly use application for lectern and altar covers, tapestries and banners. But vestments of course can also be manufactured using this technique.



1-5141



1-5343



2-5328



Techniques: hand embroidery

We have a standard collection of handembroidered emblems and bandings in stock for fast deliveries. When a design is not in stock, we do require 3 to 4 months delivery time for hand embroidery, since this technique is very time consuming and labour intensive.

We only use the best yarns for hand embroidery, ensuring a beautiful result. The great advantage of hand embroidery is that it is highly customizable. One piece can easily be finished in this technique and we will gladly help to create the perfect design for your customer if the design is not in our collection yet.

Since there are many techniques for hand embroidery (couching, mylar, frissé cannetille, etc.), we will gladly assist you in picking the best hand embroidery technique for your project, guaranteeing the satisfaction of your customer.



1-2784



1-5292



1-3870



couching



mylar



frissé cannetille



relief embroidery

Techniques: digital printing

When your customer provides you with a high-resolution picture of an image he would like to see on any parament, we will gladly assist you.

Digital printing allows us to print any image on a polyester fabric so that one vestment or set of paraments can easily be manufactured using the image. The great thing about digital printing is that the image or design may be very complex, detailed and have diverse shades of colours.

We mainly use digital printing for banners, but also love working with printed bandings or emblems or even chasubles can be printed digitally (f.ex. our Brody Neuenschwander collection).

When a large quantities of vestments is required, digital printing can also be a budget friendly solution and allows fast deliveries.



1-7510



1-5187



1-5249



1-5009

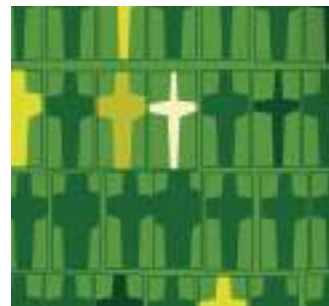

Techniques: combinations

We do offer the possibility to combine techniques. When we receive your project, we will gladly advise you on the different production techniques we can use.

Combining techniques can be interesting for budget reasons or can speed up the production if you have a strict deadline to keep. In our main collection, we already offer many paraments combining application and embroidery or combining hand with machine embroidery. Combining those techniques allows us to supply unique creations that represent the skills and creativity of our workshop.



1-5392



1-3358



1-5289



1-5283



Track & Trace

SLABBINCK®
IN SERVICE OF LITURGY SINCE 1903

Home Downloads News Team Fabrica Altarcloth configurator Contact Track & Trace

WEBSHOP VISION REFERENCES BLOG HISTORY WORKSHOP DEALERS

Home / Track & Trace

Track & Trace

Please insert your customer number and PO number

Customer number

PO number

* Please confirm all the required information, thank you.

TRACE

Tracking by E-mail

If you do not have all the required information, please write an e-mail to info@slabbinck.be. We will then gladly assist you. Please provide your name, address and date of order.



Production stages

- 0: Registration
- 1: Cutting fabric
- 2: Cutting and attaching application
- 3: Embroidery
- 4: Finishing
- 6: Steaming
- 10: Folding
- 12: Packed and ready to ship

OTHER:





- 5: Waiting (for instructions)
- 7: Not in stock
- 8: To be supplied from stock
- 11: Picking
- 13: Finished but still needs embroidery
- 15: Waiting for prepayment
- 22: Bring from stock to workshop
- 28: Prewash

- 9: Shipped, not invoiced
- 99: Shipped and invoiced but order not completed

Fabrics & Colours

				
Code 10-101-12-14	Code 20-23	Code 30-33	Code 40-41-42-43-44	
White: Light, innocence, purity, joy, triumph, glory	Red: Passion, blood, fire, God's Love, martyrdom	Green: Eternal life, hope, anticipation	Purple: Penance, preparation, sacrifice	
				
Code 50	Code 21	Code 80-81	Code 59	Code 60-62
Black: Mourning, sorrow	Rose: Anticipation, rejoicing	Blue: Blessed Virgin Mary	Grey: Ash, mourning and repentance	Gold: Joy, gold can replace white, red or green

Symbols used to show what the fabric is best used for

			
Chasubles Dalmatics Stoles	Lectern cover, Pulpit cover, Altar paraments, Altar cover, Antependium, Half Altar cover, Laudian frontal, Half Laudian frontal	Fine table linen Altar cloth	Albs

WASHING INSTRUCTIONS

Washing instructions apply to the fabric only!
Once the fabric has embroidery or application on it, washing instructions may vary.

Fabrics in alphabetical order

Adornes	124	Chiro	93	Leo	70	Moiré	81	Sentia	133
Alpha	35	Choral	84	Linen (pure)	29	Omega	51	Seta	39
Athos	37	Crux	85	Linus	144	Pascal	02	Terlenka	61
Blended Linen	38	Duomo	138	Livorno	20	Pius	54	Vaticano	67
Brugia	92	Dupion	25	Lucia	45	Prisma	26	Velours/Velvet	80
Cantate	63	Greco	77	Malta	66	Ravenna	87		
Celtic	112	Jersey	53	Melchior	19	Regina	98		

NR	QUALITY	Composition Width Weight	Best used for				WASHING INSTRUCTIONS	AVAILABLE COLOURS
02	Pascal	69% man-made fibres 30% viscose 1% gold thread 160 cm/63" 280 g/m ²	X	X			Dry clean only with petroleum solvent, if not available with perchlorethylene, very short cycle 	
19	Melchior	99% viscose 1% lurex gold 160 cm/63" 190 g/m ²	X	X			Dry clean only with petroleum solvent, if not available with perchlorethylene, very short cycle 	
20	Livorno	45% wool 55% man-made fibres 150 cm/59" 180 g/m ²				X	Dry clean only with petroleum solvent, if not available with perchlorethylene, very short cycle 	
25	Dupion	70% man-made fibres 30% viscose 150 cm/59" 200 g/m ²	X	X			Wash in warm suds, rinse well, do not wring, hang wet to dry, no ironing needed 	
26	Prisma	55% man-made fibres 45% wool 150 cm/59" 250 g/m ²				X	Dry clean only with petroleum solvent, if not available with perchlorethylene, very short cycle 	
29	Pure Linen	100% linen 290 cm/114" 170 g/m ²			X		Fully washable and dry cleanable 	
35	Alpha	95% cotton - 5 % linen 150 cm/59" 160 g/m ²			X		Fully washable and dry cleanable 	
37	Athos	70% man-made fibres 30% viscose 150 cm/59" 200 g/m ²				X	Wash in warm suds, rinse well, do not wring, hang wet to dry, no ironing needed 	
38	Blended Linen	45% man-made fibres 55% linen 112 cm/44" 220 g/m ²			X		Wash in warm suds, rinse well, do not wring, hang wet to dry, no ironing needed 	

NR	QUALITY	Composition Width Weight		Best used for				WASHING INSTRUCTION	AVAILABLE COLOURS
39	Seta	100% silk	140 cm/55"		X			Dry clean only with petroleum solvent 	
45	Lucia	53% man-made fibres 31% cotton 16% viscose	150 cm/59"	325 g/m ²	X	X		Dry clean only with petroleum solvent, if not available with perchlorethylene, very short cycle 	
51	Omega	60% man-made fibres 30% viscose 10% linen	140 cm/55"	380 g/m ²		X		Dry clean only with petroleum solvent, if not available with perchlorethylene, very short cycle 	
53	Jersey	100% man-made fibres	150 cm/59"	240 g/m ²	X		X	Wash in warm suds, rinse well, do not wring, hang wet to dry, no ironing needed 	
54	Pius	100% man-made fibres	160 cm/63"	145 g/m ²	X	X	X	Wash in warm suds, rinse well, do not wring, hang wet to dry, no ironing needed 	
61	Terlenka	70% man-made fibres 30% viscose	150 cm/59"	175 g/m ²	X		X	Wash in warm suds, rinse well, do not wring, hang wet to dry, no ironing needed 	
63	Cantate	61% wool 33% man-made fibres 6% lurex	160 cm/63"	166 g/m ²	X	X		Dry clean only with petroleum solvent, if not available with perchlorethylene, very short cycle 	
66	Malta	70% man-made fibres 30% viscose	150 cm/59"	265 g/m ²			X	Wash in warm suds, rinse well, do not wring, hang wet to dry, no ironing needed 	
67	Vaticano	70% man-made fibres 30% viscose	150 cm/59"	265 g/m ²			X	Wash in warm suds, rinse well, do not wring, hang wet to dry, no ironing needed 	

NR	QUALITY	Composition Width Weight	Best used for				WASHING INSTRUCTION	AVAILABLE COLOURS
70	Leo	90% man-made fibres 10% linen 150 cm/59" 205 g/m ²				X	Wash in warm suds, rinse well, do not wring, hang wet to dry, no ironing needed 	
77	Greco	70% man-made fibres 30% viscose 150 cm/59" 175 g/m ²				X	Wash in warm suds, rinse well, do not wring, hang wet to dry, no ironing needed 	
80	Velours Velvet	100% cotton 140 cm/55" 265 g/m ²		X			Dry clean only with petroleum solvent, if not available with perchloroethylene, very short cycle 	
81	Moiré	55% cotton 45% polyester 140 cm/47" 180 g/m ²	X	X			Dry clean only with petroleum solvent, if not available with perchloroethylene, very short cycle 	
84	Choral	100% wool 150 cm/59" 240 g/m ²		X			Dry clean only with petroleum solvent, if not available with perchloroethylene, very short cycle 	
85	Crux	85% man-made fibres 15% cotton 140 cm/55" 300 g/m ²				X	Wash in warm suds, rinse well, do not wring, hang wet to dry, no ironing needed 	
87	Ravenna	70% man-made fibres 30% viscose 150 cm/59" 210 g/m ²				X	Wash in warm suds, rinse well, do not wring, hang wet to dry, no ironing needed 	
92	Brugia	100% wool 150 cm/59" 180 g/m ²	X			X	Dry clean only with petroleum solvent, if not available with perchloroethylene, very short cycle 	
93	Chiro	100% man-made fibres 140 cm/55" 210 g/m ²				X	Wash in warm suds, rinse well, do not wring, hang wet to dry, no ironing needed 	

NR	QUALITY	Composition Width Weight	Best used for				WASHING INSTRUCTION	AVAILABLE COLOURS
98	Regina	51% cotton 32,5% man-made fibres 16,5% polyamide 140 cm/55" 410 g/m ²	X	X			Do not wash 	
112	Celtic	100% man-made fibres 160 cm / 63" 200 g/m ²	X	X			Wash in warm suds, rinse well, do not wring, hang wet to dry, no ironing needed 	
124	Adornes	100% man-made fibres 150 cm / 59" 145 g/m ²	X	X	X		Wash in warm suds, rinse well, do not wring, hang wet to dry, no ironing needed 	
133	Sentia	55% silk 45% man-made fibres 155 cm / 61" 110 g/m ²	X	X			Dry clean only with petroleum solvent, if not available with perchlorethylene, very short cycle 	
138	Duomo	100% man-made fibres 160 cm / 63" 155 g/m ²	X	X			Dry clean only with petroleum solvent, if not available with perchlorethylene, very short cycle 	
144	Linus	100% man-made fibres 160 cm / 63" 200 g/m ²	X	X			Dry clean only with petroleum solvent, if not available with perchlorethylene, very short cycle 	



Orphreys



1060



2060



3060



8060



4060



5060

Ref. 30-3003

Width 14 mm / 9/16"



1060



2060



3060



4060

Ref. 30-3005

Width 7 mm / 1/4"



2060



3060



8060

Ref. 30-3016

Width 12 mm / 1/2"



98

Ref. 30-3011

Width 12 mm / 1/2"



1460



2060



3060



4060

Ref. 30-3010

Width 65 mm / 2 1/2"



Ref. 30-3001
Width 30 mm / 1 3/16"

60



Ref. 30-3001
Width 15 mm / 9/16"

60



Ref. 30-3001
Width 15 mm / 9/16"

70



Ref. 30-3008
Width 10 mm / 3/8"

60



Ref. 30-3017
Width 40 mm / 1 5/8"

60



Ref. 30-3007
Width 30 mm / 1 3/16"

60



Ref. 30-3014
Width 65 mm / 2 1/16"

5060



Ref. 30-3015
Width 27 mm / 1"

60



Ref. 30-3004
Width 50 mm / 2"

1460



2060



6020



3060



4060



8060

Ref. 30-3002
Width 86 mm / 3 $\frac{3}{8}$ "



2060

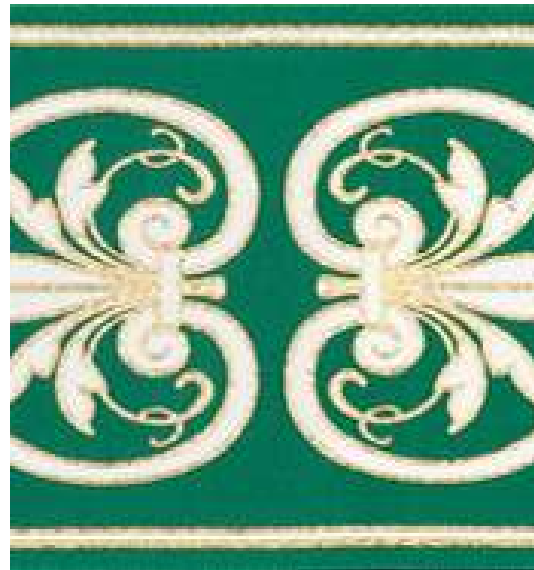

3060



4060

Ref. 31-3122
Width 75 mm / 3"

Fringes



Ref. 205-10
Width 50 mm / 2"



205-14



205-21



205-20



205-23



205-61



205-30



205-320



205-40



205-83



Ref. 205-2749-20
Width 50 mm / 2"



205-2749-30



205-2749-40

Bullion fringe



Ref. 200-60
Width
30 mm / 1 $\frac{3}{16}$ "
40 mm / 1 $\frac{5}{8}$ "
50 mm / 2"
80 mm / 3 $\frac{1}{8}$ "



Ref. 202-60
Width 50 mm / 2"

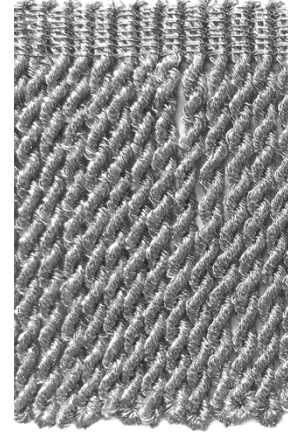

Ref. 202-70
Width 50 mm / 2"

Emblems & embroideries

22-6002



16 cm | 6 5/16"

22-6003



16 cm | 6 5/16"

22-6004



16 cm | 6 5/16"

22-6005



16 cm | 6 5/16"

22-6006



16 cm | 6 5/16"

22-6008



16 cm | 6 5/16"

22-6080



16 cm | 6 5/16"

22-6081



16 cm | 6 5/16"

22-6001



16 cm | 6 5/16"

22-6007



16 cm | 6 5/16"

22-6083



16 cm | 6 5/16"

22-6023



16 cm | 6 5/16"

22-6033



16 cm | 6 5/16"

22-6043



16 cm | 6 5/16"

22-6020



16 cm | 6 5/16"

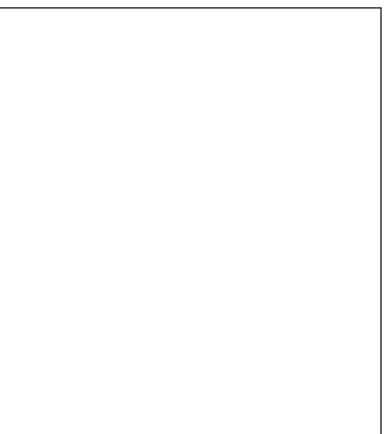
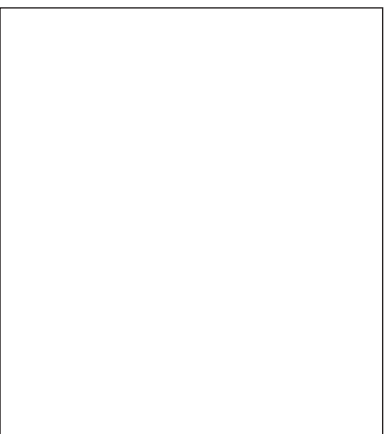
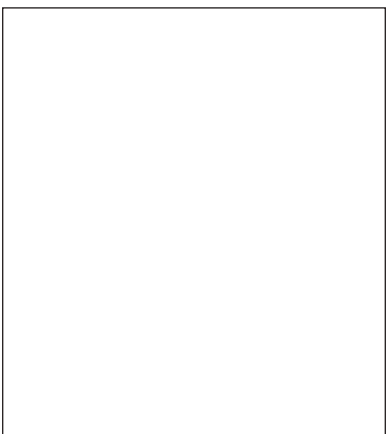
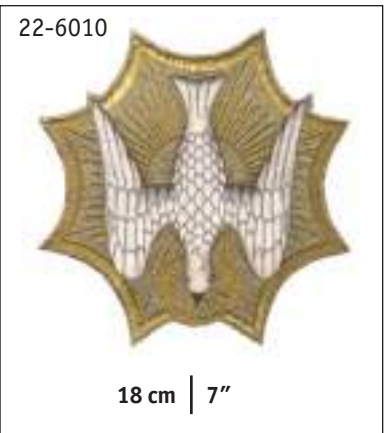
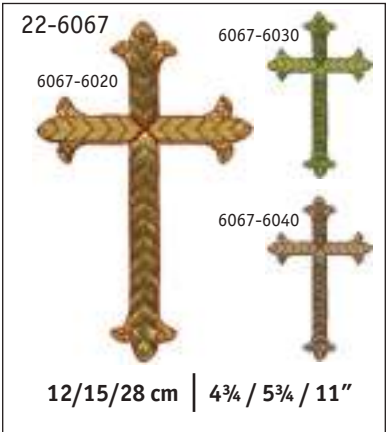
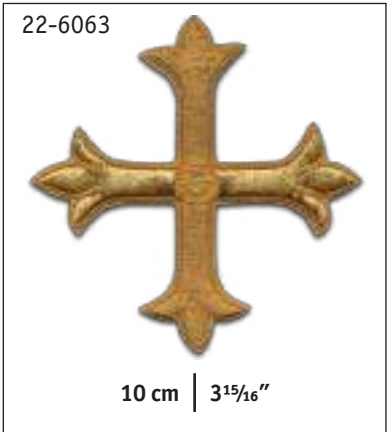
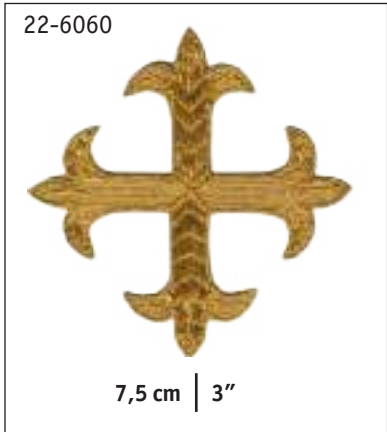

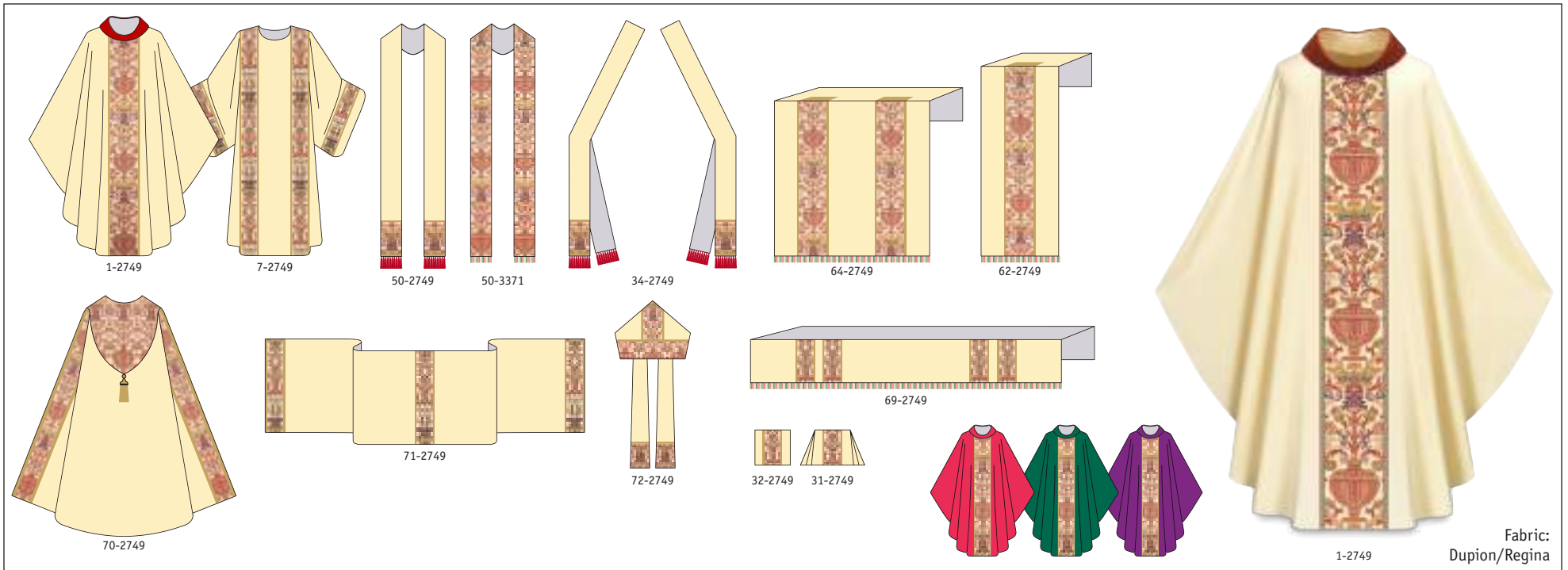

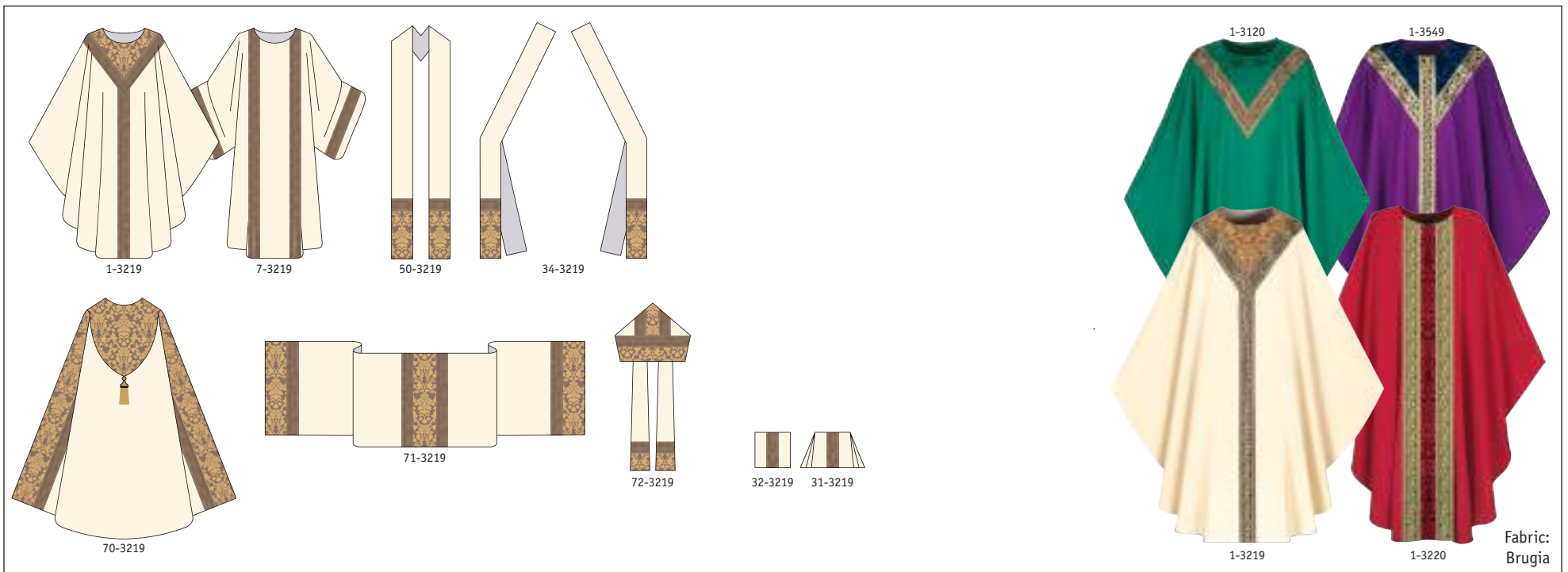
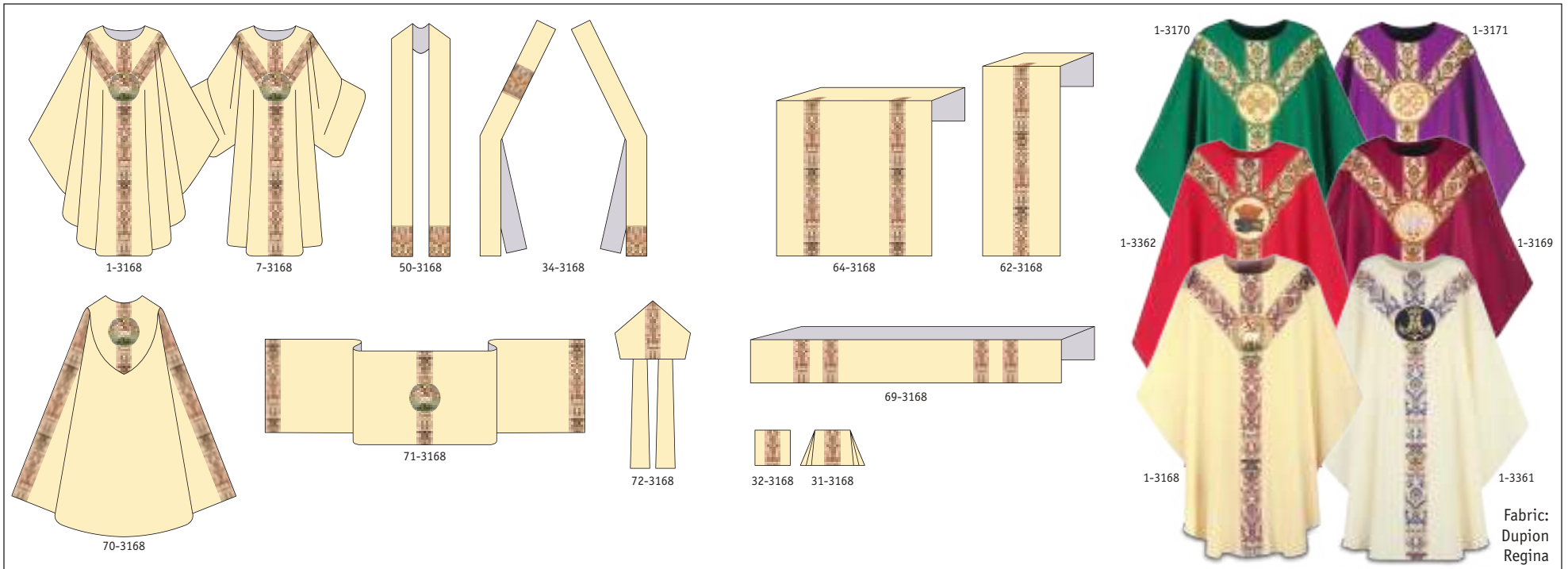

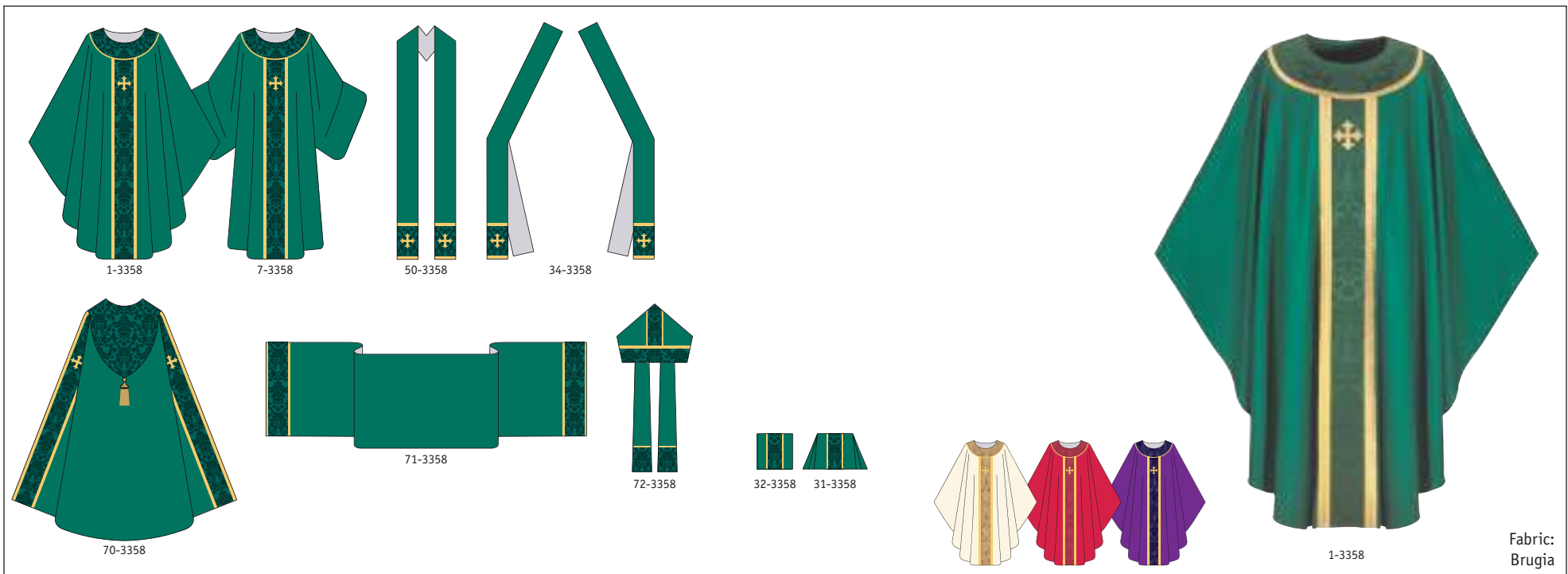
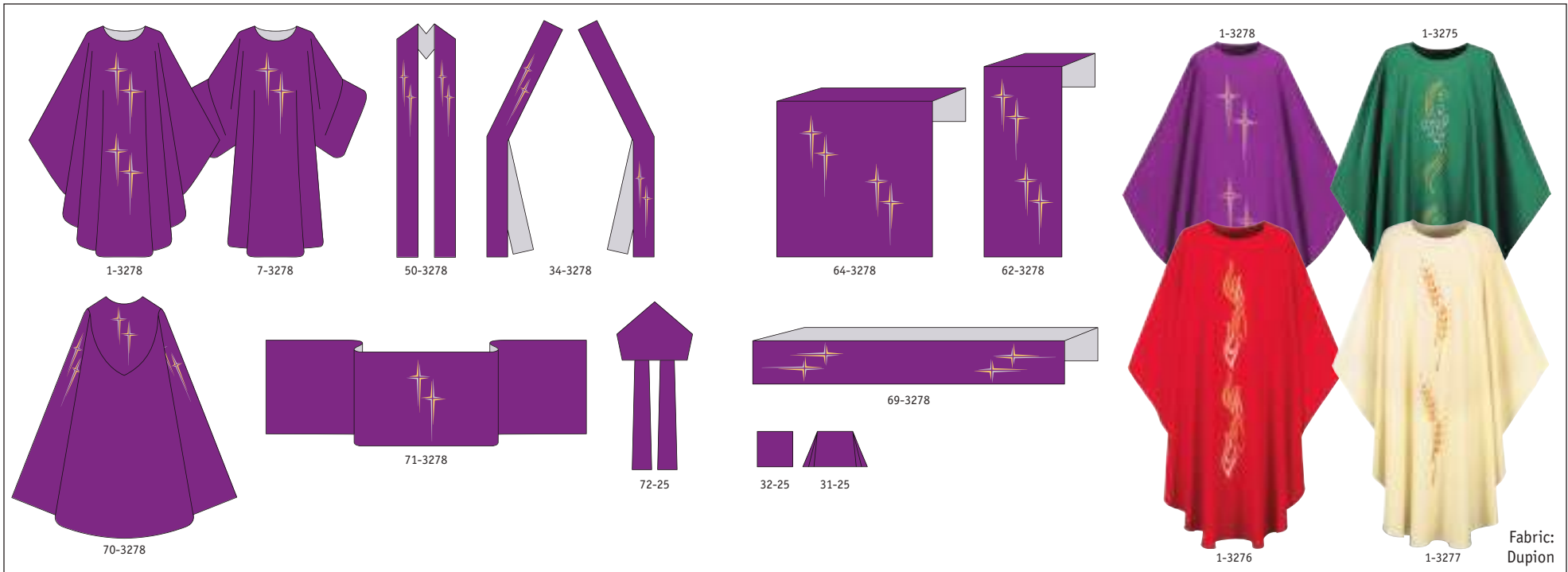



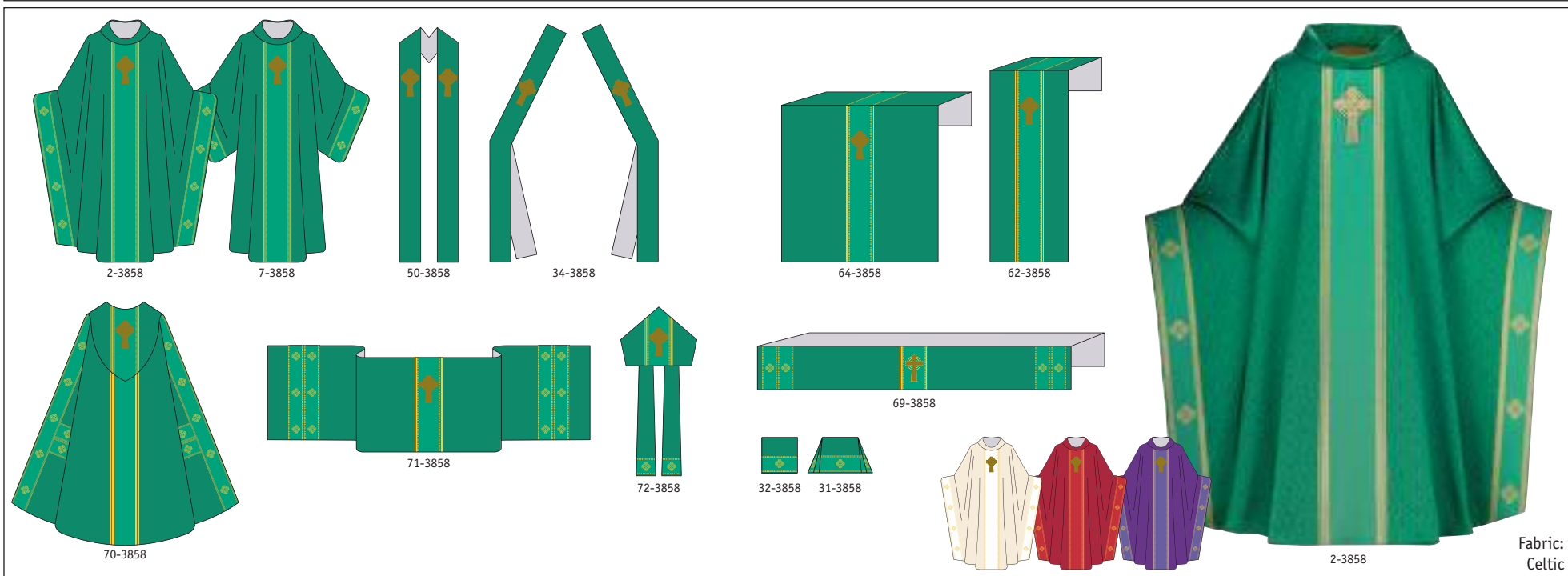
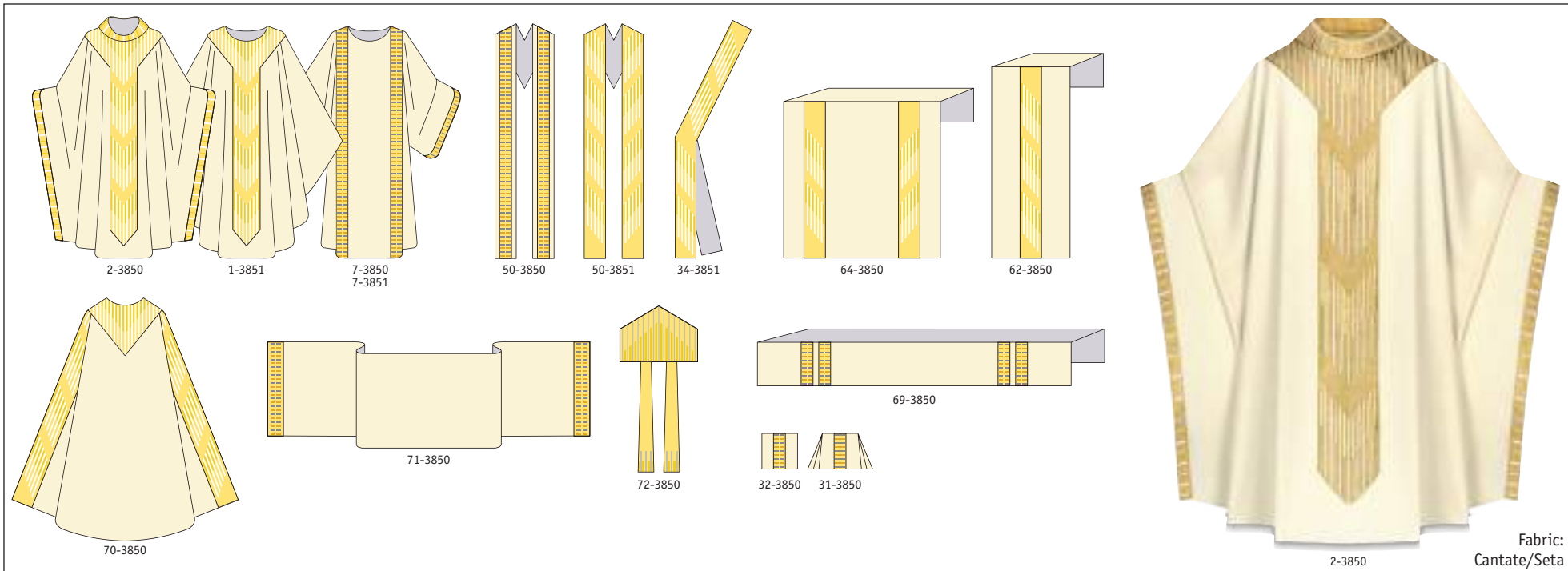

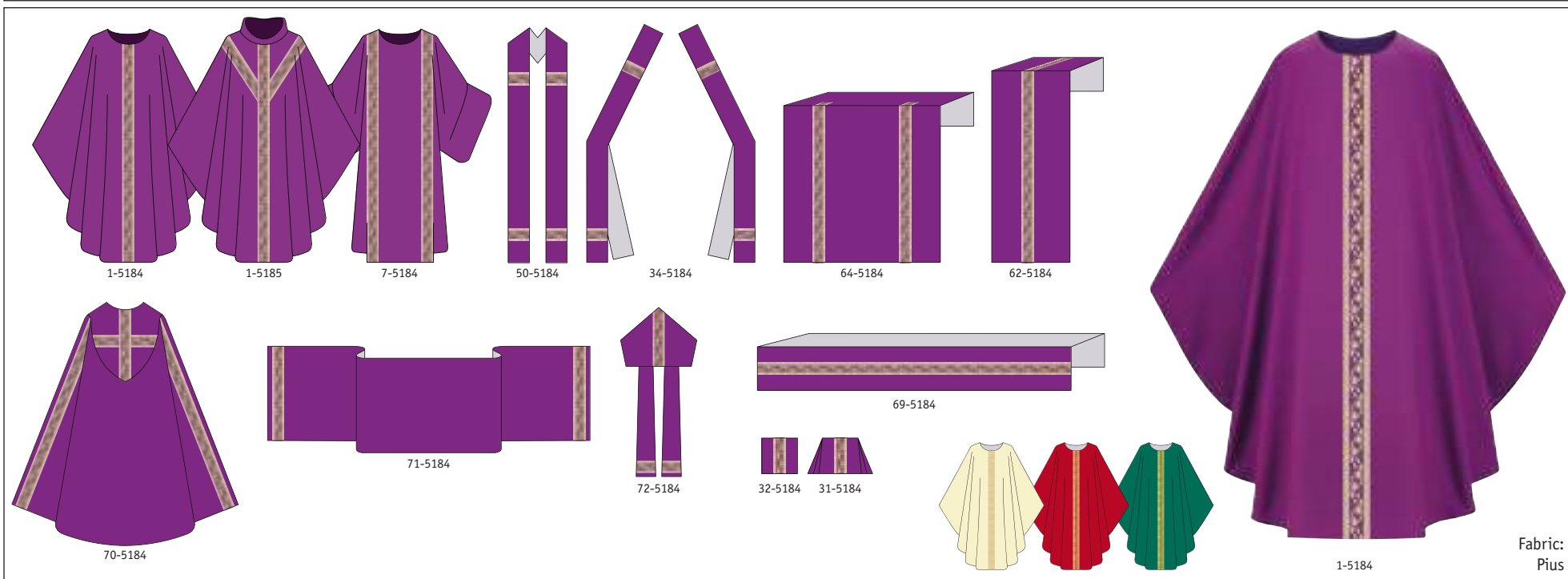

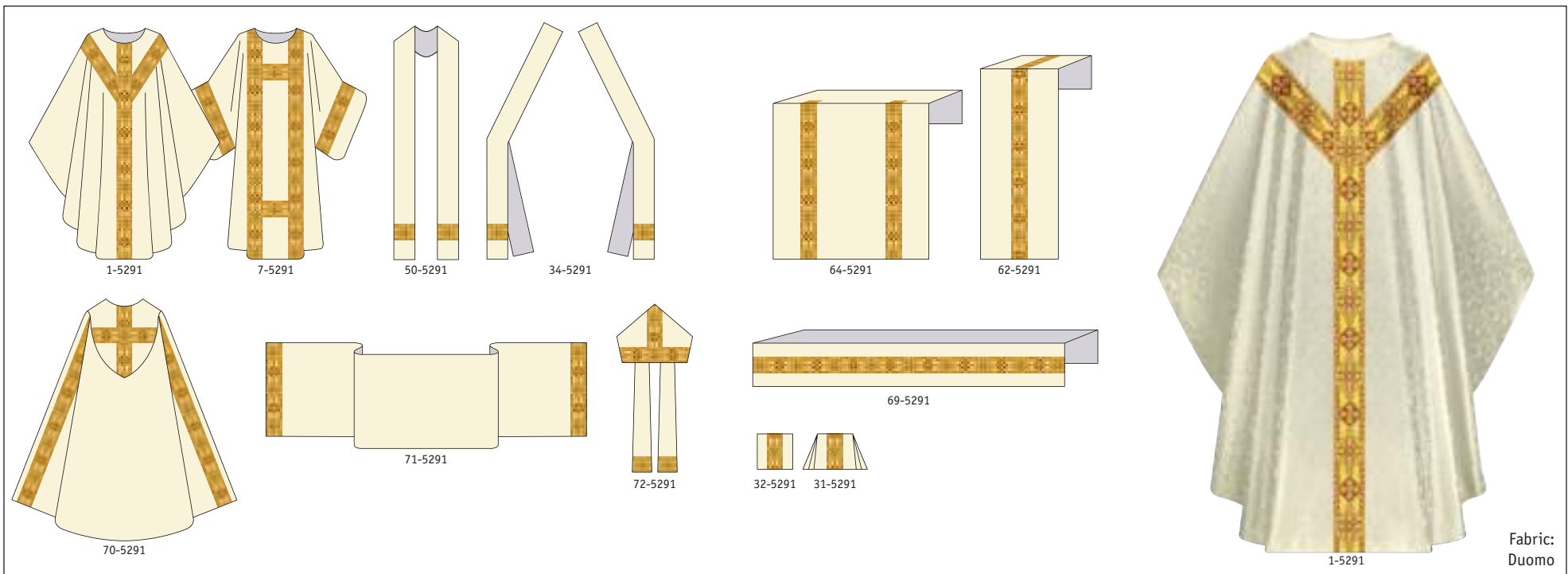
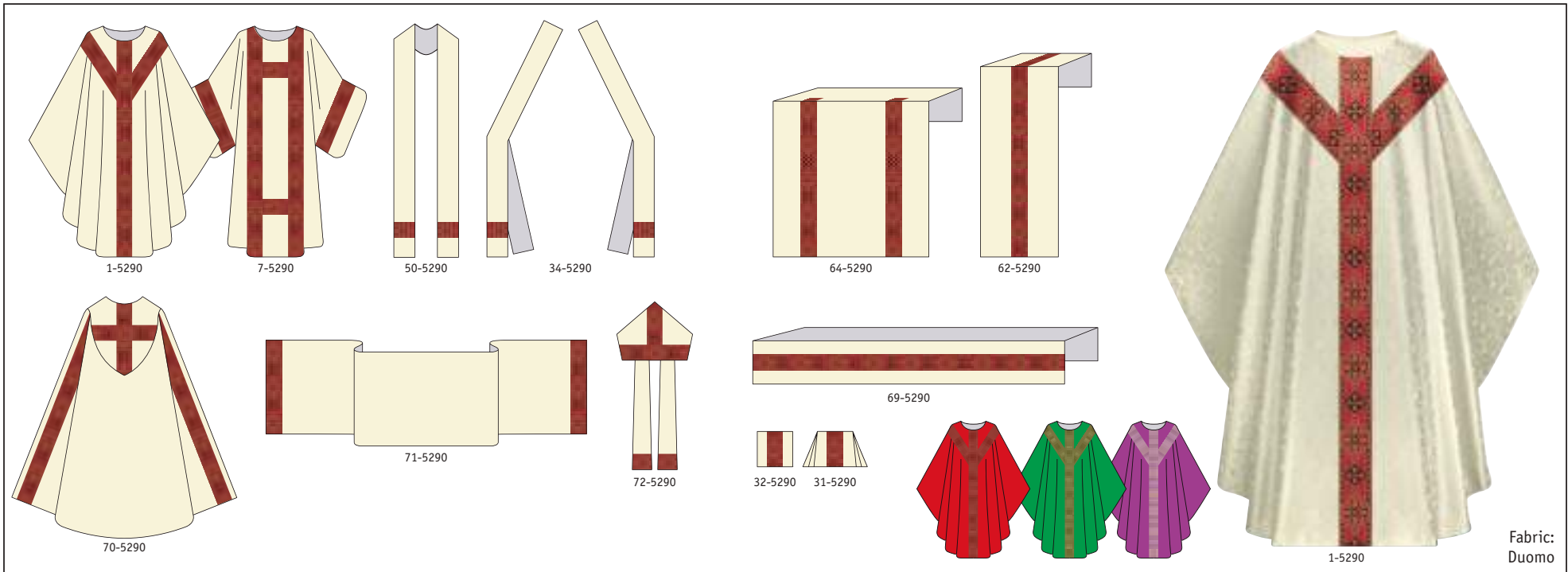

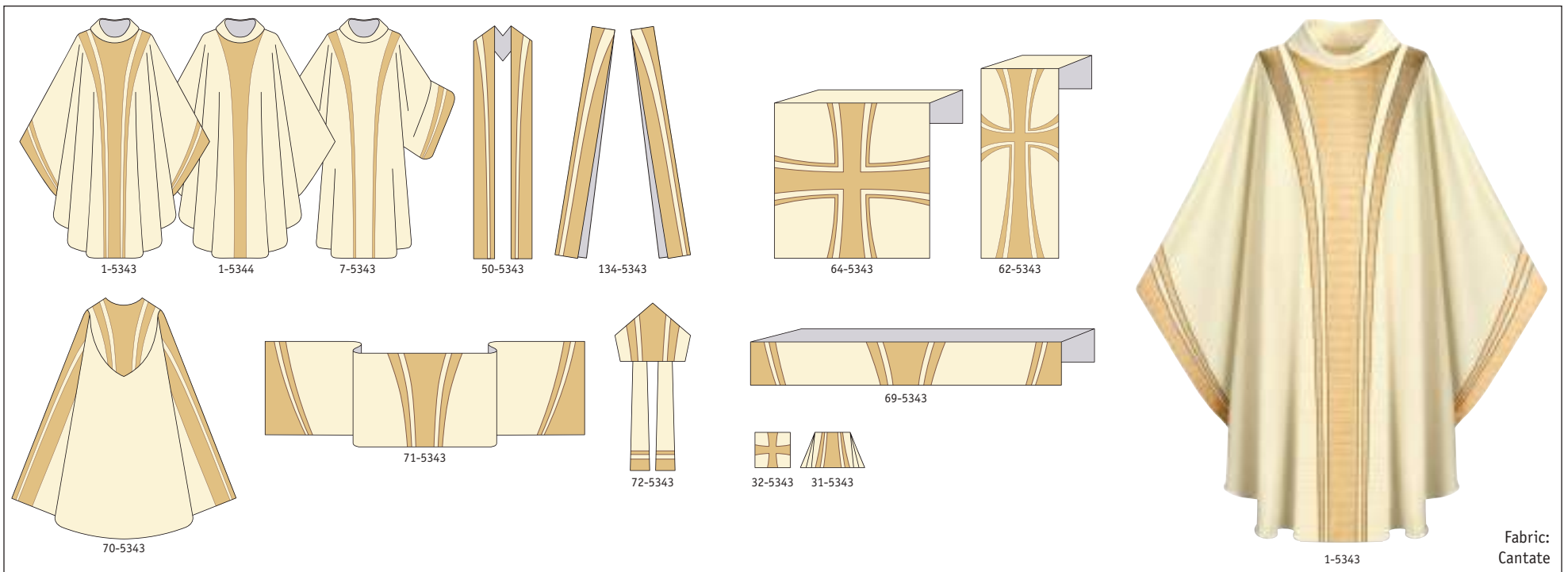
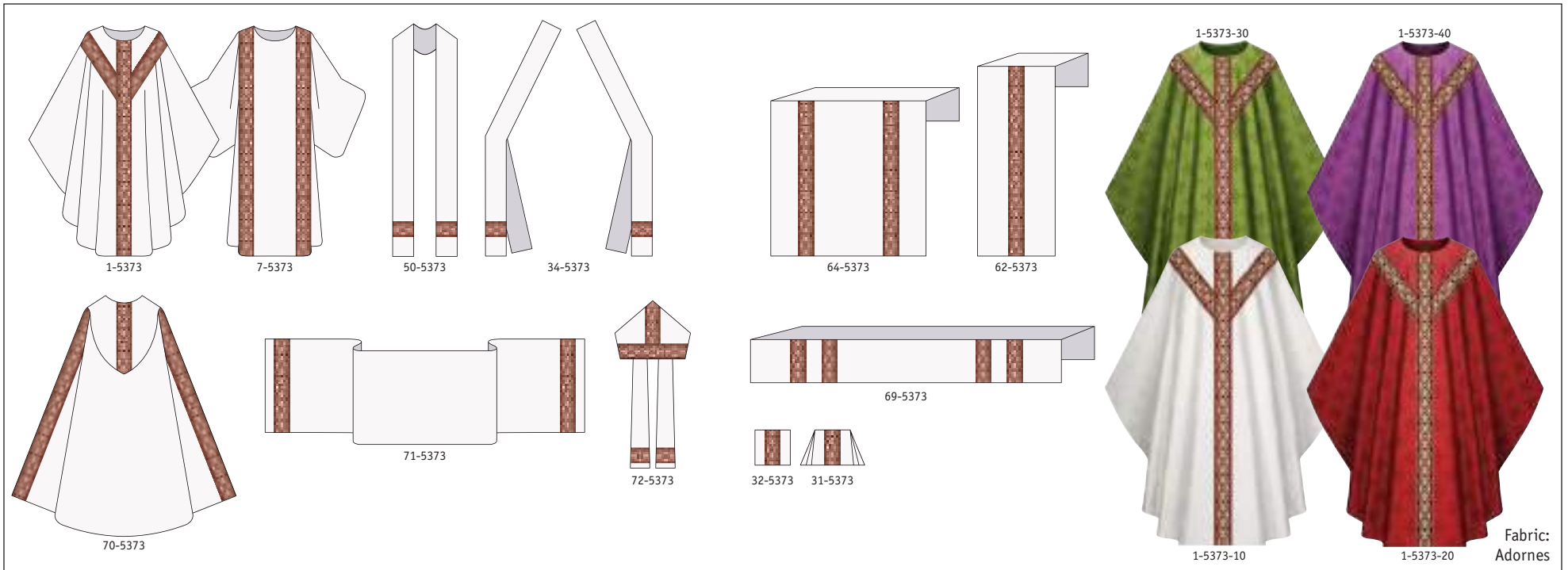

General information: sizes and finishes

Gothic Chasuble art. 1, Monastic Chasuble art. 2

Prices include (unless otherwise specified):

- small chasuble or dalmatic stole to be worn under the garment;
- if embroidered, same embroidery on front and back;
- neck finish according to catalogue;
- unlined.

Standard size chasuble

Style	A = width	B = length	Supplement
Small	150-160 cm / 59"-63"*	125 cm / 49"	Basic price
Standard	150-160 cm / 59"-63"*	135 cm / 53"	Basic price

* According to the width of the fabric, see information fabrics for vestments and paraments, pages 17 to 21.

Special size chasuble

2	Supplement monastic chasuble	
9	Special, custom-made	upon request

Small chasuble stole

	A = width	B = length
Standard	11 cm / 4¼"	135 cm / 53"

Special size upon request.

Available at extra charge:

Chalice veil, unlined, 58 x 58 cm / 23"x 23" / 61 x 61 cm / 24"x 24" **upon request**
 Chalice veil, lined, 58 x 58 cm / 23"x 23" / 61 x 61 cm / 24"x 24" **upon request**
 Burse, 20 x 20 cm / 8"x 8" / 23 x 23 cm / 9" x 9" **upon request**
 Benediction burse (without embroidery), 23 x 23 cm / 9" x 9" **upon request**
 Small chasuble or dalmatic stole to be worn under chasuble or dalmatic.
 Lining for chasuble or dalmatic.

Neck finish

F = neck size; H = height of collar or capuche. The neck finish indicated in the catalogue is included in the price; other neck finishes are available at extra charge or reduction.

N°	Neck finish	F	H
0	Plain	64 cm / 25"	-
1	Plain neckline, with zipper left shoulder	62 cm / 24¾"	-
3	Roll-collar	66 cm / 26"	12 cm / 4¾"
4	Roll-collar	65 cm / 25½"	9 cm / 3½"
6	Low stand-up collar	68 cm / 26¾"	8 cm / 3½"
6A	As 6, embroidered	68 cm / 26¾"	8 cm / 3½"

Gothic Chasuble

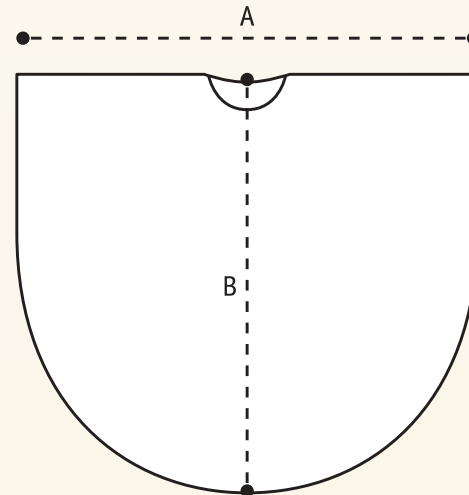

Monastic Chasuble

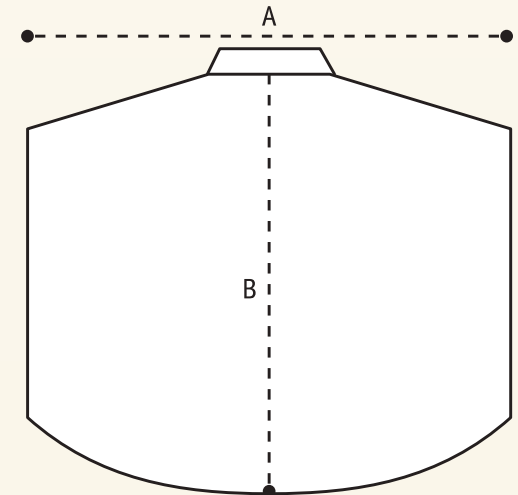

Small chasuble stole

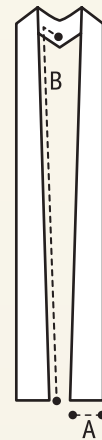

Neck finish

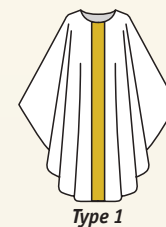

General information: sizes and finishes

Conical Chasuble art. 199

Standard size

Width A = 220 cm - 87"
Length B = 140 cm - 55"

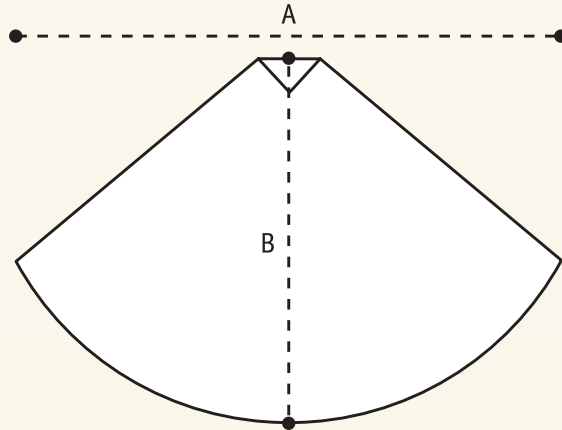

Canterbury Chasuble art. 399

Standard size

Width A = 120 cm - 47"
Length B = 140 cm - 55"

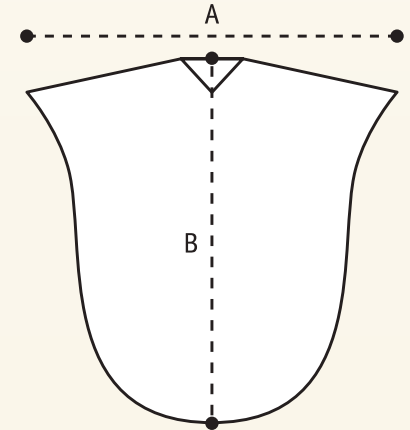

Roman Chasuble art. 299, Stole art. 230 and Maniple art. 233

• Roman chasuble set art. 298

Price of the set includes: stole, maniple, chalice veil and burse

• Roman chasuble art. 299

Standard size

Width A = 67 cm - 26"
Length B = 105 cm - 41"

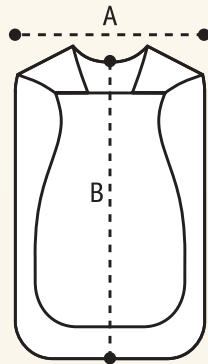

Roman Chasuble

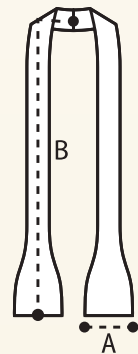

Stole



Maniple



• Stole art. 230

Standard size

Width A = 15 cm - 6"
Length B = 105 cm - 41"

• Maniple art. 233

Standard size

Width A = 15 cm - 6"
Length B = 50 cm - 19½"

• Chalice veil art. 31

Width A = 58 cm - 23"
Length B = 58 cm - 23"

• Burse art. 32

Width A = 23 cm - 9"
Length B = 23 cm - 9"

Dalmatic art. 7

A matching dalmatic is available for each chasuble. With matching embroidery or orphreys, price upon request.

When ordering, please indicate style I, II, III or IV.

Standard size: same size as chasubles.

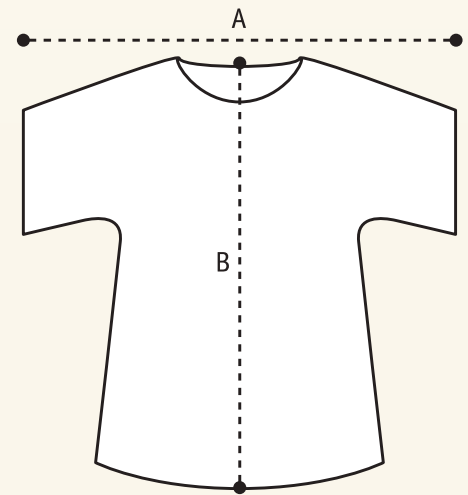
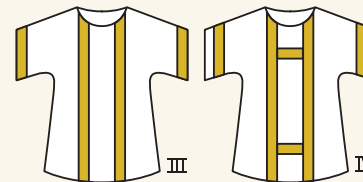
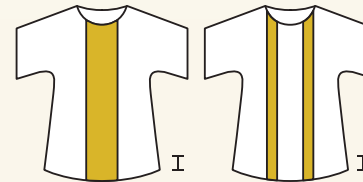

General information: sizes and finishes

Overlay stole art. 50

• Overlay stole, art. 50 (single-sided or reversible)

Always lined and interlined; available with different neck finishes, supported by an elegant chain (except for style 107), which prevents the stole from rubbing neck or hair, and saves the need for a stole protector.

I Single-sided overlay stole

Style and neck finishes: A = width at ends; B = overall length, neck finishes included. The neck finish indicate in the catalogue is included in the price; other neck finishes are available at extra charge or reduction.

Style	Neck finish	Width A	Length B
16	Full tapered flat capuche; spreading out towards ends	16 cm / 6 ⁵ / ₁₆ "	160 cm / 63"
25	Flat capuche	12 cm / 4 ³ / ₄ "	145 cm / 57"
38	Tapered flat capuche	12 cm / 4 ³ / ₄ "	155 cm / 61"
65	Flat rounded neck finish	12 cm / 4 ³ / ₄ "	145 cm / 57"
75	Stand-up collar	12 cm / 4 ³ / ₄ "	145 cm / 57"
86	Pointed flat capuche; spreading out towards ends	16 cm / 6 ⁵ / ₁₆ "	160 cm / 63"
107	Rounded neck	13 cm / 5 ¹ / ₈ "	145 cm / 57"

II Reversible overlay stole art. 51

Manufactured like the overlay stole, but reversible: white-purple, red-green or other colour combinations.

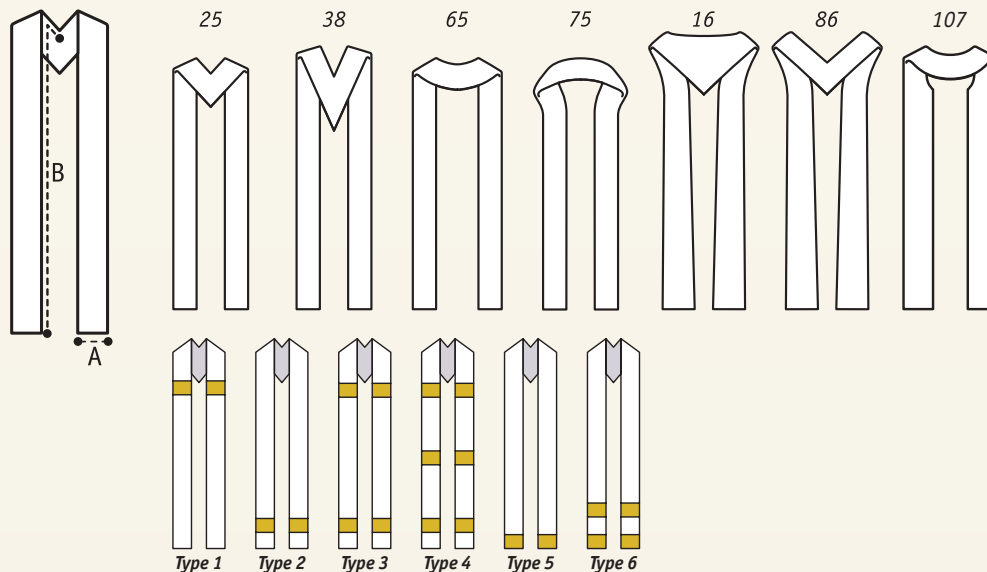

Deacon stole art. 34

• Deacon stole, art. 34

Matching the design of the overlay stole. Worn from left shoulder to right hip. Deacon stoles will be delivered for a standard chest size 95-115 cm/37"-45". On request deacon stoles can be made to custom size at no additional charge. Standard chest size (95-115 cm/37"-45") will be supplied unless otherwise requested.

Style 34: embroidery in front at chest height, on back on lower panel (price see style 25).

Style 134: Crossed style.

Style 434: Byzantine cut, with band front and back (price see 86).

Style	Type	Width A	Length B
34	Standard	12 cm / 4 ³ / ₄ "	145 cm / 57"
34	Standard larger size upon request	12 cm / 4 ³ / ₄ "	155 cm / 61"
134	Crossed style	12 cm / 4 ³ / ₄ "	145 cm / 57"
434	Byzantine	12 cm / 4 ³ / ₄ "	130 cm / 51"

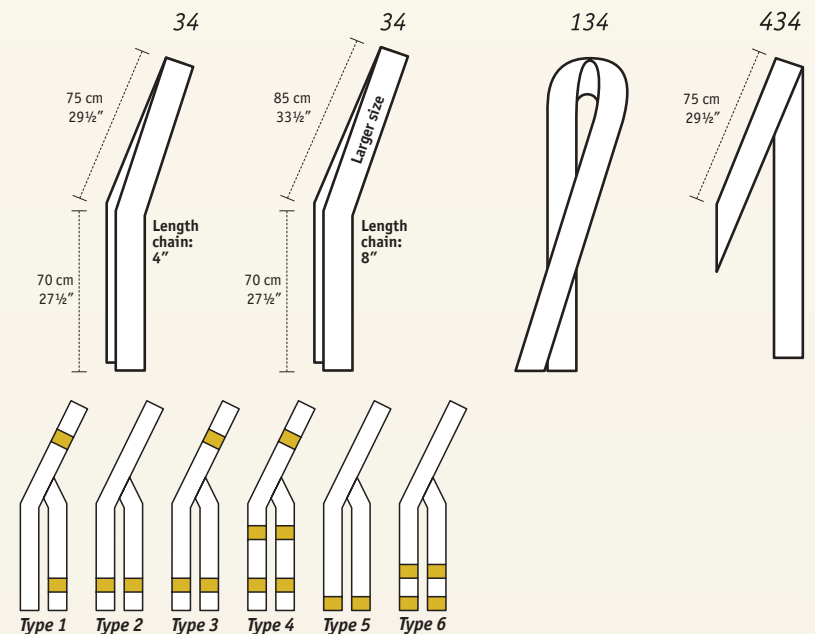

General information: sizes and finishes

For standard and special sizes and neck finishes, as shown on illustrations, charts and sketches.

All measurements are given in cm and in inches. We supply size and neckline according to the illustration in the catalogue unless otherwise specified on your order.

Additional charges may apply for special designs and measurements.

How to interpret our references

The general structure of our references is as follows: **article / design number / fabric / colour / extra / neck / size / finish.**

Field Comment

> **Article** (3 digits) articles 1-499 are textile line articles.
articles 500-999 are metal and other trade articles.

> **Design** (5 digits) design number as shown in the catalogue.

> **Fabric** (3 digits) fabric number.

> **Colour** (3 digits) the most common colours are:

10 white	20 red	30 green	40 purple	50 black
101 ecru	21 rose	33 dark-green	42 indigo	59 grey
12 off-white	23 dark red			60 gold
14 beige	28 red/green			80 blue
18 white/purple				

> **Extra** (1 digit) 1 = inside stole included 0 = no inside stole

> **Neck** (1 digit)* neck number (6A is referenced as 9) for chasubles.

> **Size** (1 digit)* * for stoles, the combination of the neck and size fields, determine the style.
For instance: neck 2, size 5 = style 25, or neck 3, size 8 = style 38

> **Finish** (2 digits) for albs: size - for other products: finishing code.

We also use EAN13 (GTIN) barcodes on our standard articles. Our barcodes are composed as follows: 541 (Belgium) 4737 (Slabbinck), followed by 6 digits.

Klerikos *shirts* have a special referencing:

- article **521**

- design number : e.g. 5541 => 55 (black romano) + European size 41.

Surplice art. 14, 414, 214, 444

Standard size

Chest sizes: 105 cm/41" (adults).

Only A-B = length to be indicated when ordering:

SIZE

For altar servers:

- 1) 40 cm/16"
- 2) 50 cm/19½"
- 3) 60 cm/24"
- 4) 70 cm/27"
- 5) 80 cm/31½"

For adults:

- 1) 90 cm/35" (small),
- 2) 97,50 cm/38" (medium)
- 3) 105 cm/41" (large)

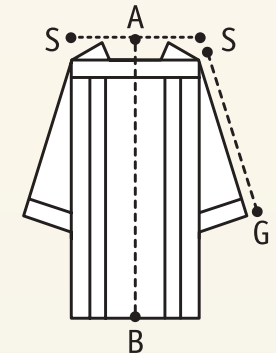

Special size

I Standard size with adjustments

Indicate A-B = length, S-S = shoulder to shoulder and S-G = sleeve length when ordering.

Supplement

II Entirely custom-made

Please give the following measurements: A-B = length, C = male chest size or female bust size, S-S = shoulder to shoulder, S-G = sleeve length.

Supplement

Cope art. 70, Humeral veil art. 71, Mitre art. 72

• Cope art. 70

When ordering, indicate A-B = length of cope and person's total height (length of the cope is 35 cm/14" less than person's height).

Without indication of length, we supply standard size 145 cm/57".

Supplement lining for cope.

Supplement textile closure 15 x 15 cm / 6" x 6"

Overlay stole or inside stole **NOT** included in price of cope. Please order separately.

• Humeral veil, art. 71

Available with matching decoration. Standard finish is always with clasps and with pockets in lining.

Size: 54 x 275 cm / 21" x 108".

• Mitre, art. 72

When ordering, please indicate head size.

Cope

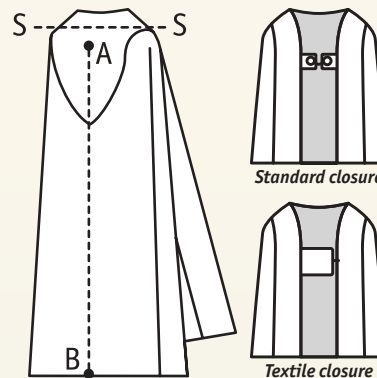

Humeral veil

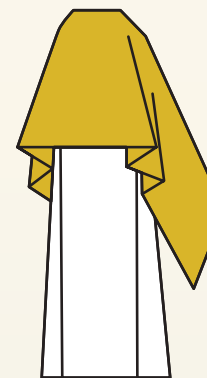

Mitre

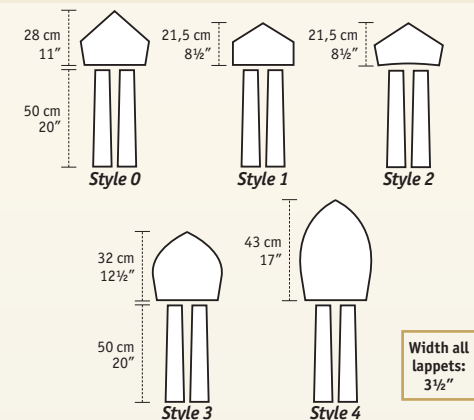

General information: sizes and finishes

Lectern cover, Pulpit cover, Altar paraments, Altar cover, Antependium, Half Altar cover

Lined and interlined; finished with an open hem at the top and the bottom; microphone opening to order.

• Lectern cover, art. 62

A = width up to 60cm/24" (at indicated price, without supplement);
D = front drop; C = depth; E = back drop; D + C + E = overall length.

Standard sizes D + C + E = 180cm/71". A = 45cm/18". D = 110cm/43".

Special sizes If longer or deeper than standard sizes, price upon request.

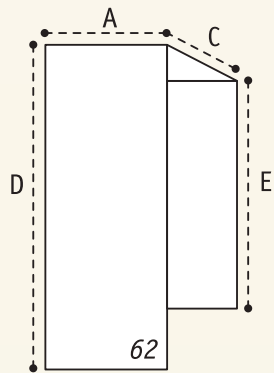

• Pulpit cover, art. 115

Same finish as lectern cover art. 62, but with different standard sizes and special sizes.

Standard sizes D + C = 100cm/39 3/8". A = 45cm/17 3/4". D = 55cm/21 3/8".

Special sizes If longer or deeper than standard sizes, (same as for lectern cover art. 62) price upon request.

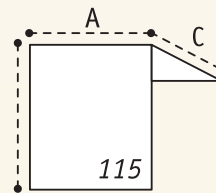

• Altar paraments, art. 114

Same finish as lectern cover art. 62, but with different standard sizes and special sizes.

Standard sizes D + C + E = 150cm/59". A = 45cm/17 3/4". D = 75cm/29 1/2".

Special sizes If longer or deeper than standard sizes, (same as for lectern cover art. 62) price upon request.

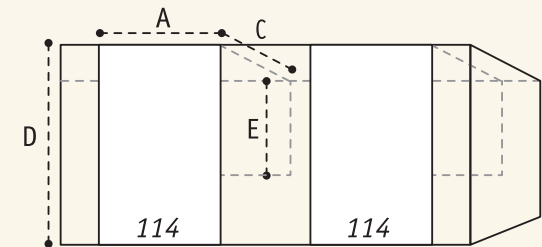

• Altar cover, art. 64

A = width up to 105cm/42" (at indicated price, without supplement);
D = front drop; C = depth; E = back drop; D + C + E = overall length.

Standard sizes D + C + E = 190cm/75". A = 90cm/36". D = 90cm/36".

Special sizes If longer or deeper than standard sizes, price upon request.

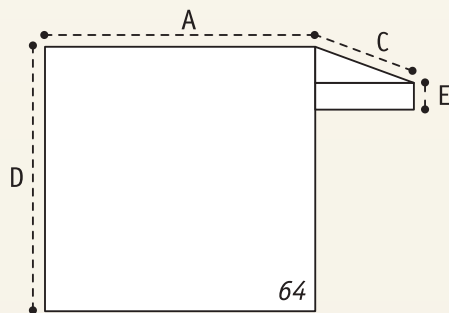

• Antependium, art. 112

A = width up to 180cm/71" (at indicated price, without supplement);
D = front drop; C = depth; E = back drop; D + C + E = overall length.

Standard sizes D + C + E = up to 190cm/75". A = up to 180cm/71".

D = 90cm/36".

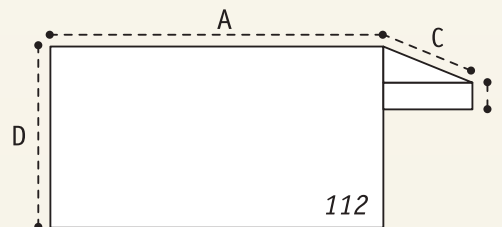

• Half altar cover, art. 113

Same as antependium, style 112 but with different standard sizes and special sizes.

Standard sizes D + C + E = up to 130cm/51". A = up to 180cm/71".

D = 35cm/14".

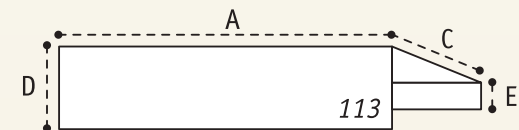

General information: sizes and finishes

Altar cloth, Laudian frontal, Half Laudian frontal

Microphone opening and special cut-out (e.g. tabernacle) to order*.

• Altar cloth, art. 63

When ordering, indicate measurements for **finished** altar cloth;

A = length of mensa; B = side drops; C = depth of mensa;

D = front drop; E = back drop.

If depth (C) is over the width of the fabric, the altar cloth is finished with a seam.

There is 1 meter / 1 yard minimum charge. The necessary fabric is added to the altar cloth (style 63), to compensate for shrinkage during the first launderings. Due to variables in laundering (water temperature, chemicals in detergents, etc.) the fabrics may shrink more or less than anticipated. Therefore, all altar cloths are provided with large 1½" hems to be adjusted if necessary.

The front and back drop of type IV, are always attached by seams to the altar cloth for this reason there is an extra charge of 10%.

Prewash is possible upon request (supplement).

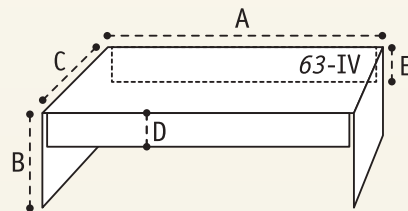
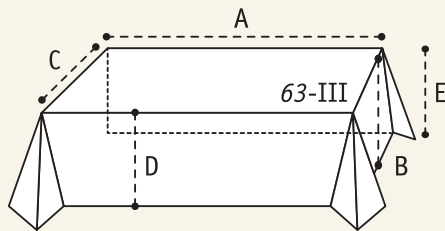
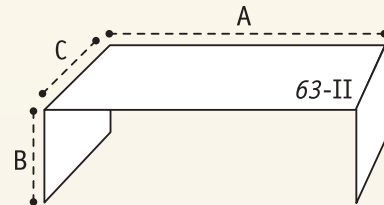
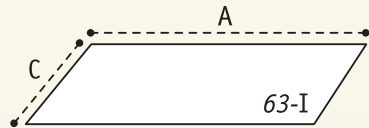

• Laudian frontal, art. 66

Covers the altar on all sides, corners are rounded. Interlined. Finished with a middle seam in the length.

When ordering, indicate measurements for **finished** laudian frontal:

A = length of mensa; C = depth; D and E = equal front and back drops, usually 2" less than altar height.

Special sizes : If the measurement A is more than 180 cm/71", price upon request.

If the measurement C + D + E is more than twice the usable width of the fabric, price upon request.

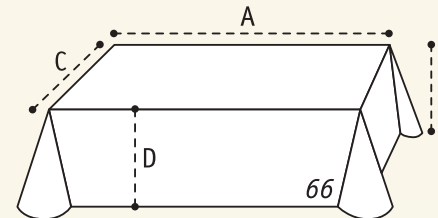

• Half Laudian frontal, art. 166

Same as laudian frontal, style 66, but with shorter front, back and side drops D and E up to 10".

Special sizes above indicated measurements, price upon request.

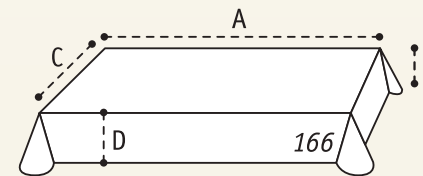

Interchangeable superfrontal

• Interchangeable superfrontal, art. 69

Adorns front of altar cloth. When ordering, please indicate:

A = length of mensa; (standard length 180 cm/71" supplement per extra cm/inch, price upon request)

D = height (standard height 25 cm/10"; same price up to 30 cm/12". Over 30 cm/12": price upon request.

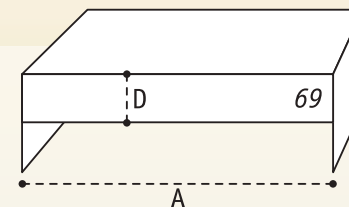

* Microphone opening, supplement

Special cut-out, supplement

No deduction for less than standard size.

ALB

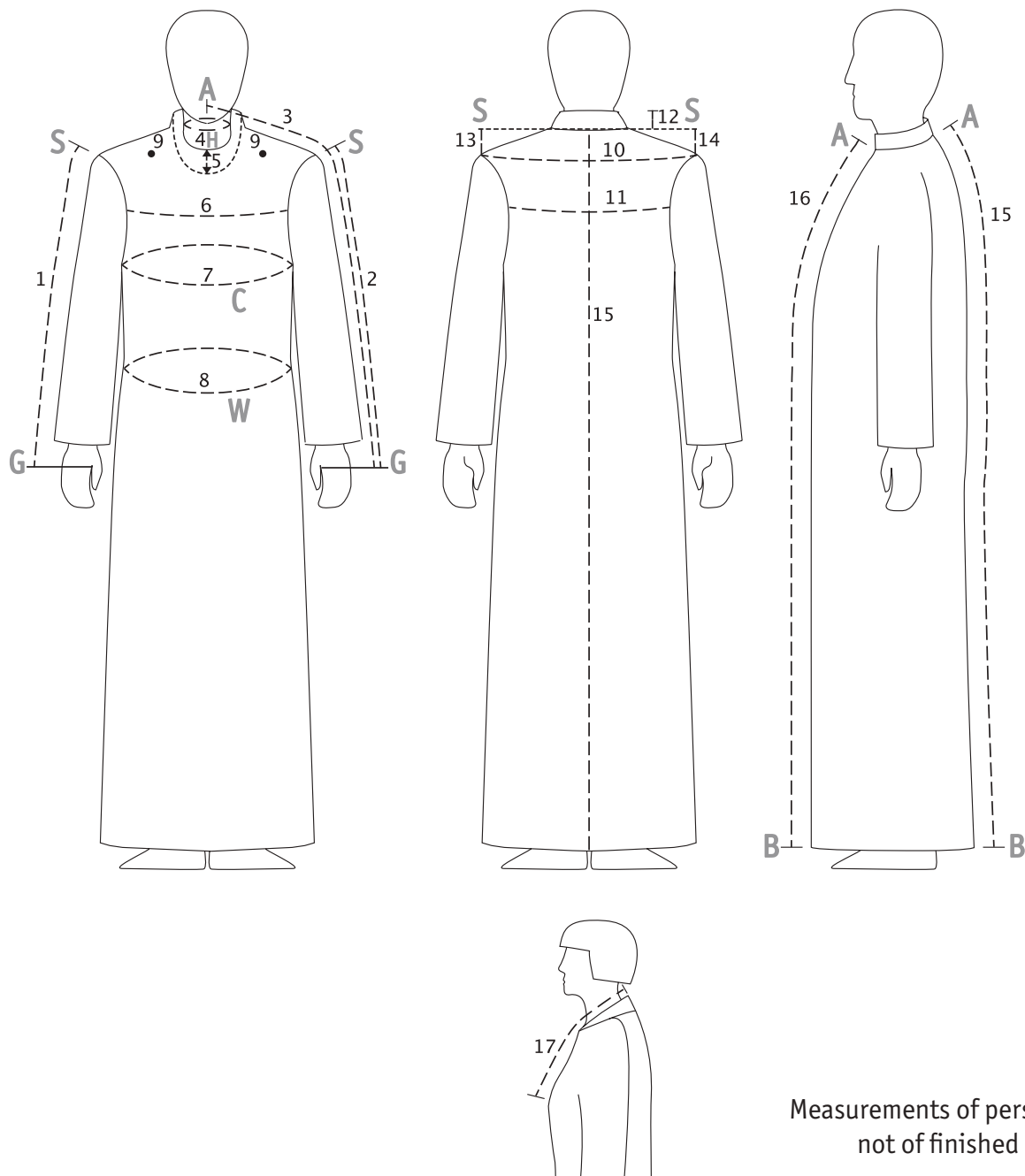

Measurements of person,
not of finished alb!

1	Sleeve length left	S-G
2	Sleeve length right	S-G
3	Total sleeve length	A-G
4	Neck	H
5	Cut out collar in front	
6	Width in front	
7	Chest size	C
8	Waist	W
9	Button Position	
10	Shoulder size	S-S
11	Back width	
12	Height of collar	
13	Take shoulder size left	
14	Take shoulder size right	
15	Total back length	A-B
16	Total front length	A-B
17	Size neck-breast	

Albs for adults

Styles: there are three general styles:

1 Coat style: (styles 11, 73, 93, 100, 300)

With fixed amice concealing clothing underneath, with fabric-covered buttons for a perfect fit; with two elegant front and back pleats.

The garment is adapted for wearing under a chasuble; as a vestment for concelebration, for baptism, home Mass or for lectors.

2 Sanctuary alb with roll-collar: (style 44)

This garment is pulled over the head. Wide sleeves. Neck finish with roll-collar in front and capuche at the back.

3 Liturgical gown with full and ample and wide sleeves: (styles 95, 195)

Monastic style is pulled over the head. With a deep hood (95) or with a roll-collar (195).

For all styles:

- > Convenient coat style.
- > Collar finished with fixed amice, concealing clothing underneath (no separate amice needed).
- > With fabric-covered buttons for perfect fit.
- > Can replace cassock and surplice.
- > Two elegant front and back pleats guarantee complete freedom of movement;
- > Style for men; two slits for access to trouser pockets; style for woman; with two pockets.
- > Can be worn with or without cincture.
- > Manufactured in wash-and-wear fabrics. We recommend hanging to dry.

Fabrics:

There is no such thing as the "best fabric". It all depends on which aspect your customer finds most important: warmth, wrinkling, easy-care or price:

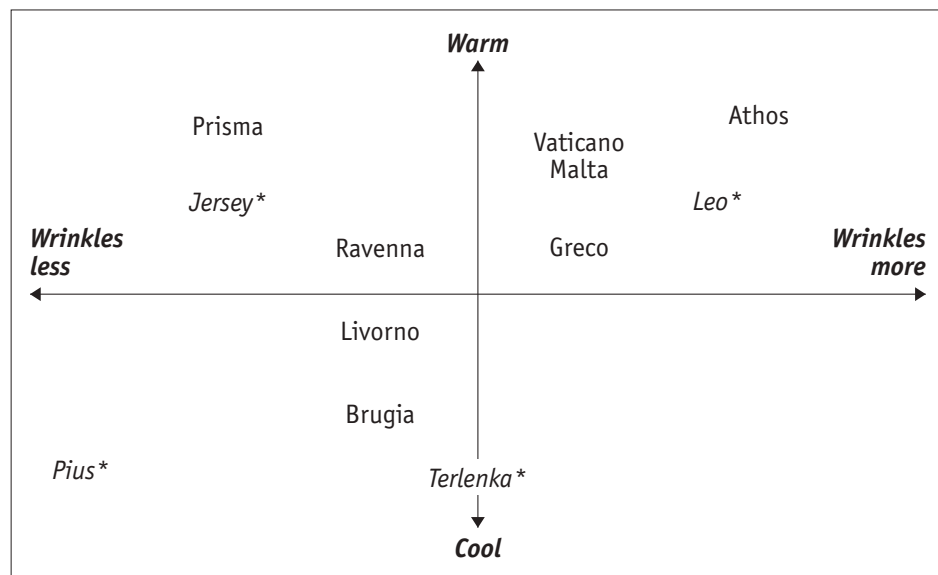

* EASY CARE

Sizes:

1 Standard sizes

Indicate length A-B = from base of the neck to the top of the shoe (usually approx. 30cm/12" less than person's total height); standard neck size 44 cm/17 1/4" for the shirt size n° 15 to 17. C = chest. Standard sizes:

MEN length A-B	Chest C				LADIES length A-B	Chest C				
	95 cm/37" slim	105 cm/41" regular	115 cm/45" large	125 cm/49" extra large		80-85 cm 31"-34"	85-95 cm 34"-37"	95-105 cm 37"-41"	105-115 cm 41"-45"	115-125 cm 45"-49"
140 cm - 55"	SK	MK (14)	LK	50	130 cm - 51"	L6	-	-	-	-
145 cm - 57"	0	2	5	51	132,5 cm - 52"	L8	-	-	-	-
150 cm - 59"	1	3	6	52	135 cm - 53"	-	L10	L11	-	-
155 cm - 61"	8	4	7	53	137,5 cm - 54"	-	L12	L13	-	-
160 cm - 63"	SG	MG (16)	LG	54	140 cm - 55"	-	-	L14	-	-
					145 cm - 57"	-	-	-	L15	-
					150 cm - 59"	-	-	-	-	L16

Should your order not specify (C), regular (105 cm/41") for men and (95-105 cm/34"-37") for ladies will be supplied.

Style 11, coat style, amice collar, double front and back pleats, set-in sleeves, 2 pockets slits standard, ladies has one pocket.				Styles with decoration in sleeves and skirt of garment.			
Style	Fabric	Colour		Style	Fabric	Colour	
11	Brugia	all colours		73	Greco	beige	
11	Greco	beige		93-3445	Terlenka	white	
11	Jersey	white		100	Greco	beige	
11	Leo	flax-white		300	Ravenna	white	
11	Livorno	white, beige or black					
11	Pius	white, beige, ecru or black					
11	Prisma	beige					
11	Ravenna	white					
11	Terlenka	white, black (as cassock) and other colours					
11	Vaticano	beige					

2 Standard size with some adjustments

- > Back length A-B and sleeve length S-G only
- Supplement, price upon request.

3 Entirely custom-made

- Please use the sizing chart on the left.
- Extra's: pockets.
- Supplement, price upon request.

ALBS FOR ALTAR BOYS: there are two general styles:

1- to be pulled over the head: (styles 4, 37)

Monastic style with roll collar (4), scapular effect with zipper on shoulder (37)

2- coat style with zipper in front: (style 5, 10, 13, 205)

Small capuche (5), stand up collar (205), deep capuche (10), mandarin style collar (13)

CASSOCK

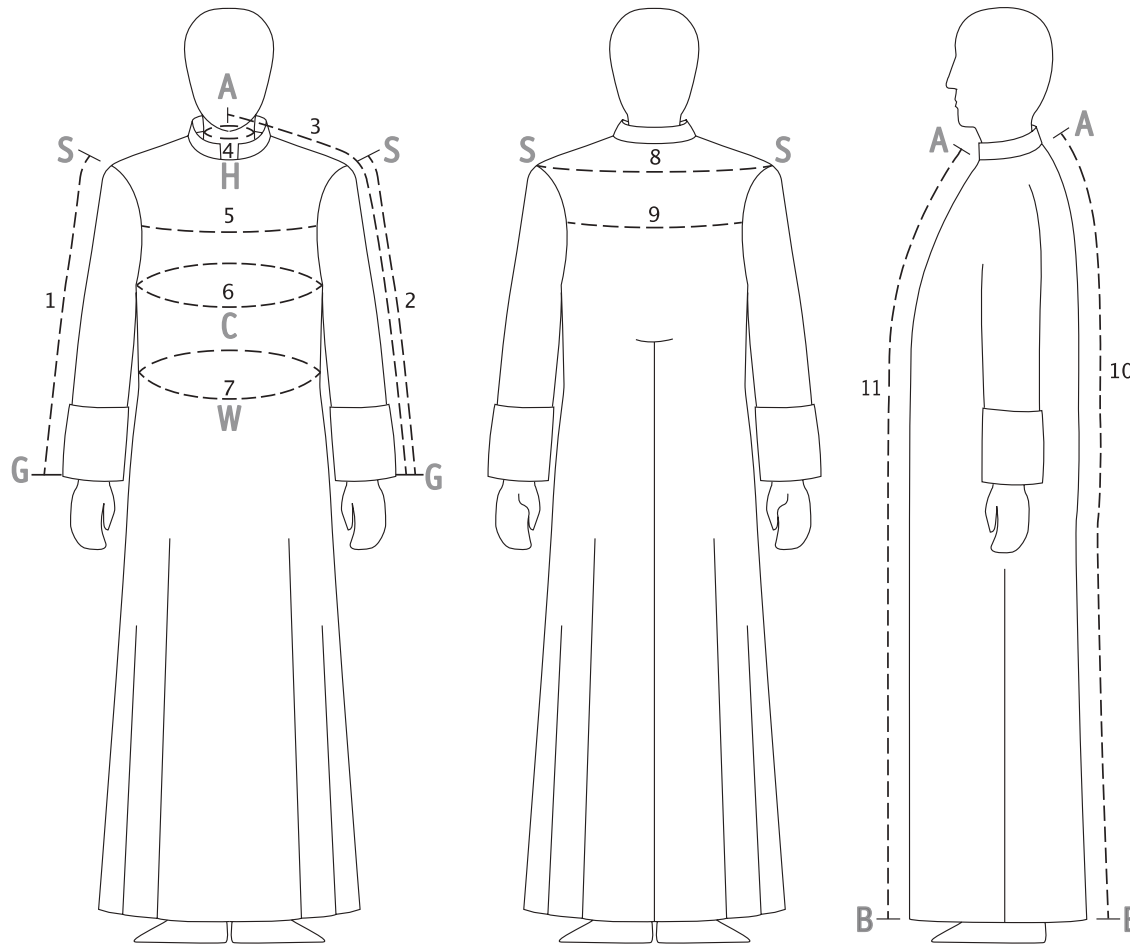

1	Sleeve length right	S-G
2	Sleeve length left	S-G
3	Total sleeve length	A-G
4	Neck	H
5	Front width	
6	Chest	C
7	Waist	W
8	Shoulders	S-S
9	Back width	
10	Total length	A-B
11	Total length front	A-B

Measurements of person,
not of finished cassock!

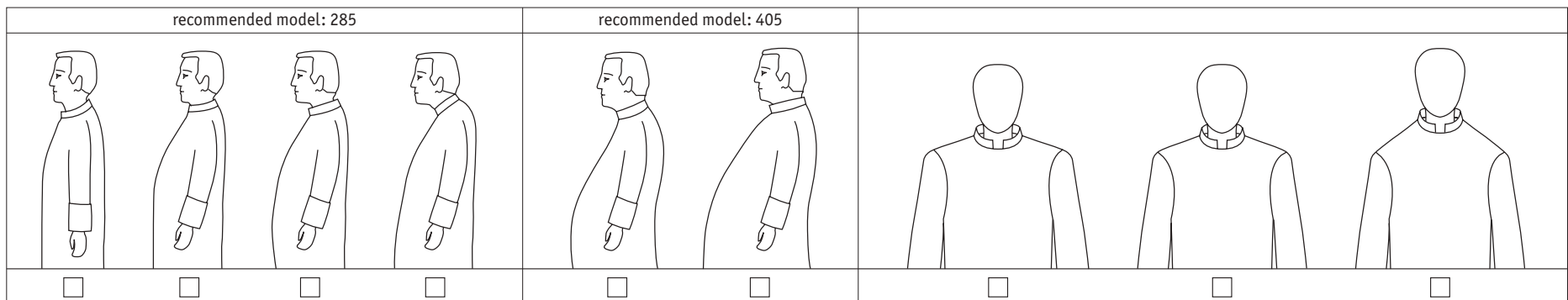

Cassock & cassock-alb

• Cassock.

Art. **285**: with stand-up collar, has slits to the trousers pockets, fabric-covered buttons, lining in sleeves and down to the waist. Dry cleaning required.

285 Cassock, Brugia

285 Cassock, Terlenka

285 Cassock, Livorno

285 Cassock, Prisma (not available in black)

Extra for special neckline

***When ordering please indicate size A-B.**

MEN Standard size	C Chest size up to ...	W Waist size up to ...	H Neck size	S-S Shoulder to shoulder
C2*	97 cm 38"	89 cm 35"	38/39 15-15½"	41 16"
C3*	102 cm 40"	94 cm 37"	39/40 15½"-16"	43 17"
C4*	107 cm 42"	99 cm 39"	41/42 16"-16½"	45 17¾"
C5*	112 cm 44"	104 cm 41"	42/43 16½"-17"	47 18½"
C6*	117 cm 46"	109 cm 43"	43/44 17-17½"	50 19½"
C7*	122 cm 48"	114 cm 45"	44/45 17½"-18"	52 20½"
C8*	127 cm 50"	119 cm 47"	45/46 18"-18½"	54 21¼"



• Cassock-alb.

Art. **405**: coat style; with stand-up collar; has slits to the trousers pockets; turn-back concealing zipper; two side pleats on front and back.

405 Terlenka

405 Leo (not available in black)

405 Prisma (not available in black)

405 Livorno

Standard lengths: same standard sizes as for alb.



LADIES Standard size	C Chest size up to ...	W Waist size up to ...	H Neck size	S-S Shoulder to shoulder	A-B Total length	S-G Total sleeve length
LC1*	92 cm 36"	83 cm 32"	38,5 15"	38 cm 15"	135 cm 53"	61 cm 24"
LC2*	97 cm 38"	88 cm 34"	40 15¾"	40,5 cm 15¾"	140 cm 55"	62 cm 24½"
LC3*	102 cm 40"	93 cm 36"	41,5 16¼"	42,75 cm 16¾"	145 cm 57"	63 cm 24¾"
LC4*	107 cm 42"	98 cm 38"	42,5 16¾"	45 cm 17¾"	150 cm 59"	64 cm 25¼"
LC5*	112 cm 44"	103 cm 40"	43,5 17¼"	48,5 cm 19"	155 cm 61"	65 cm 25½"
LC6*	117 cm 46"	108 cm 42"	45 17¾"	50,5 cm 19¾"	160 cm 63"	66 cm 26"
LC7*	122 cm 48"	113 cm 44"	46 18"	53 cm 20¾"	165 cm 65"	67 cm 26¼"
LC8*	127 cm 50"	118 cm 46"	47 18½"	55,5 cm 21¾"	170 cm 67"	68 cm 26¾"

Cassock and cassock-alb entirely custom-made.
Please use the sizing chart on the left.

Clergy-shirts Classico

A wide cut shirt, made with **long** sleeves. To enhance comfort, shirt has a double pleat in the back, one breast pocket and convertible French cuffs, for closure with either buttons or cuff links.

Classico #16

100% cotton



Ref.	Colour	Size Euro	Size US	Sleeve length US
1638	Black	38	15	33-35
1639	Black	39	15-½	33-35
1640	Black	40	N/A	N/A
1641	Black	41	16	33-35
1642	Black	42	16-½	35-37
1643	Black	43	17	35-37
1644	Black	44	17-½	35-37
1645	Black	45	18	35-37
1646	Black	46	18-½	35-37
1648	Black	48	19	35-37
1649	Black	49	19-½	35-37
1650	Black	50	20	35-37
1652	Black	52	20-½	35-37
1654	Black	54	21	35-37

Classico #17

100% cotton



Ref.	Colour	Size Euro	Size US	Sleeve length US
1738	Light grey	38	15	Long
1739	Light grey	39	15-½	Long
1740	Light grey	40	N/A	Long
1741	Light grey	41	16	Long
1742	Light grey	42	16-½	Long
1743	Light grey	43	17	Long
1744	Light grey	44	17-½	Long
1745	Light grey	45	18	Long
1746	Light grey	46	18-½	Long
1748	Light grey	48	19	Long
1749	Light grey	49	19-½	Long
1750	Light grey	50	20	Long

Clergy-shirts Tradicio

A wide cut shirt, made with **long** sleeves. To enhance comfort, shirt has a double pleat in the back, two breast pockets and convertible French cuffs, for closure with either buttons or cuff links.

Tradicio #812

65% polyester 35% combed cotton



Ref.	Colour	Size Euro	Size US	Sleeve length us
81238	Black	38	15	Long
81239	Black	39	15 -1/2	Long
81240	Black	40	15 -3/4	Long
81241	Black	41	16	Long
81242	Black	42	16 -1/2	Long
81243	Black	43	17	Long
81244	Black	44	17 -1/2	Long
81245	Black	45	17 -3/4	Long
81246	Black	46	18	Long
81247	Black	47	18 -1/2	Long
81248	Black	48	19	Long
81249	Black	49	19 -1/2	Long
81250	Black	50	20	Long
81252	Black	52	20 -1/2	Long

Tradicio #813

65% polyester 35% combed cotton



Ref.	Colour	Size Euro	Size US	Sleeve length us
81338	Black	38	15	Extra long
81339	Black	39	15 -1/2	Extra long
81340	Black	40	15 -3/4	Extra long
81341	Black	41	16	Extra long
81342	Black	42	16 -1/2	Extra long
81343	Black	43	17	Extra long
81344	Black	44	17 -1/2	Extra long
81345	Black	45	17 -3/4	Extra long
81346	Black	46	18	Extra long
81347	Black	47	18 -1/2	Extra long
81348	Black	48	19	Extra long
81349	Black	49	19 -1/2	Extra long
81350	Black	50	20	Extra long
81352	Black	52	20 -1/2	Extra long

Tradicio #814

65% polyester 35% combed cotton



Ref.	Colour	Size Euro	Size US	Sleeve length us
81438	Light Grey	38	15	Long
81439	Light Grey	39	15 -1/2	Long
81440	Light Grey	40	15 -3/4	Long
81441	Light Grey	41	16	Long
81442	Light Grey	42	16 -1/2	Long
81443	Light Grey	43	17	Long
81444	Light Grey	44	17 -1/2	Long
81445	Light Grey	45	17 -3/4	Long
81446	Light Grey	46	18	Long
81448	Light Grey	48	19	Long
81449	Light Grey	49	19 -1/2	Long
81450	Light Grey	50	20	Long
81452	Light Grey	52	20 -1/2	Long

Tradicio #815

65% polyester 35% combed cotton



Ref.	Colour	Size Euro	Size US	Sleeve length us
81538	Light Grey	38	15	Extra long
81539	Light Grey	39	15 -1/2	Extra long
81540	Light Grey	40	15 -3/4	Extra long
81541	Light Grey	41	16	Extra long
81542	Light Grey	42	16 -1/2	Extra long
81543	Light Grey	43	17	Extra long
81544	Light Grey	44	17 -1/2	Extra long
81545	Light Grey	45	17 -3/4	Extra long
81546	Light Grey	46	18	Extra long
81548	Light Grey	48	19	Extra long
81549	Light Grey	49	19 -1/2	Extra long
81550	Light Grey	50	20	Extra long
81552	Light Grey	52	20 -1/2	Extra long

Clergy-shirts Classico / Tradicio

A wide cut shirt, made with **short** sleeves. To enhance comfort, shirt has a double pleat in the back.

Classico #31
100% cotton



Ref.	Colour	Size Euro	Size US	Sleeve length us
3138	Black	38	15	Short
3139	Black	39	15 -1/2	Short
3140	Black	40	15 -3/4	Short
3141	Black	41	16	Short
3142	Black	42	16 -1/2	Short
3143	Black	43	17	Short
3144	Black	44	17 -1/2	Short
3145	Black	45	17 -3/4	Short
3146	Black	46	18	Short
3148	Black	48	19	Short
3149	Black	49	19 -1/2	Short
3150	Black	50	20	Short

Classico #35
100% cotton



Ref.	Colour	Size Euro	Size US	Sleeve length us
3538	Light Grey	38	15	Short
3539	Light Grey	39	15 -1/2	Short
3540	Light Grey	40	15 -3/4	Short
3541	Light Grey	41	16	Short
3542	Light Grey	42	16 -1/2	Short
3543	Light Grey	43	17	Short
3544	Light Grey	44	17 -1/2	Short
3545	Light Grey	45	17 -3/4	Short
3546	Light Grey	46	18	Short
3548	Light Grey	48	19	Short
3549	Light Grey	49	19 -1/2	Short
3550	Light Grey	50	20	Short

Tradicio #811
65% polyester 35% combed cotton



Ref.	Colour	Size Euro	Size US	Sleeve length us
81138	Black	38	15	Short
81139	Black	39	15 -1/2	Short
81140	Black	40	15 -3/4	Short
81141	Black	41	16	Short
81142	Black	42	16 -1/2	Short
81143	Black	43	17	Short
81144	Black	44	17 -1/2	Short
81145	Black	45	17 -3/4	Short
81146	Black	46	18	Short
81147	Black	47	18 -1/2	Short
81148	Black	48	19	Short
81149	Black	49	19 -1/2	Short
81150	Black	50	20	Short
81152	Black	52	20 -1/2	Short

Tradicio #819
65% polyester 35% combed cotton



Ref.	Colour	Size Euro	Size US	Sleeve length us
81938	Light Grey	38	15	Short
81939	Light Grey	39	15 -1/2	Short
81940	Light Grey	40	15 -3/4	Short
81941	Light Grey	41	16	Short
81942	Light Grey	42	16 -1/2	Short
81943	Light Grey	43	17	Short
81944	Light Grey	44	17 -1/2	Short
81945	Light Grey	45	17 -3/4	Short
81946	Light Grey	46	18	Short
81948	Light Grey	48	19	Short
81949	Light Grey	49	19 -1/2	Short
81950	Light Grey	50	20	Short
81952	Light Grey	52	20 -1/2	Short

Clergy-shirts Torino

Made of a soft easy care fabric, with a full attached Roman collar all around neckline.

Short sleeves, **long** sleeves or **extra long** sleeves with closure for cuff links. No breast pockets.

Torino #861

65% polyester and 35% cotton



Ref.	Colour	Size Euro	Size US	Sleeve length us
86138	Black	38	15	Short
86139	Black	39	15 - $\frac{1}{2}$	Short
86140	Black	40	15 - $\frac{3}{4}$	Short
86141	Black	41	16	Short
86142	Black	42	16 - $\frac{1}{2}$	Short
86143	Black	43	17	Short
86144	Black	44	17 - $\frac{1}{2}$	Short
86145	Black	45	17 - $\frac{3}{4}$	Short
86146	Black	46	18	Short
86147	Black	47	18 - $\frac{1}{2}$	Short
86148	Black	48	19	Short
86149	Black	49	19 - $\frac{1}{2}$	Short
86150	Black	50	20	Short
86152	Black	52	20 - $\frac{1}{2}$	Short

Torino #862

65% polyester and 35% cotton

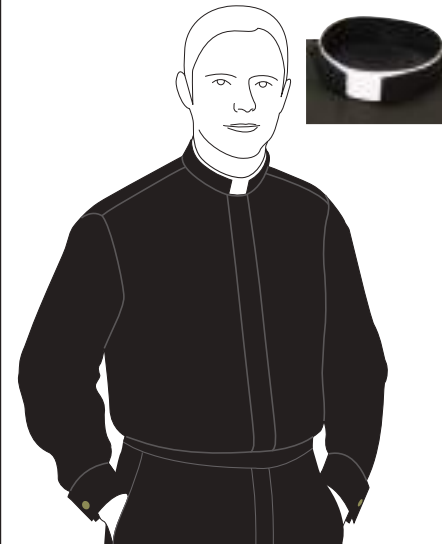

Ref.	Colour	Size Euro	Size US	Sleeve length us
86238	Black	38	15	33"-35"
86239	Black	39	15 - $\frac{1}{2}$	33"-35"
86240	Black	40	15 - $\frac{3}{4}$	33"-35"
86241	Black	41	16	33"-35"
86242	Black	42	16 - $\frac{1}{2}$	33"-35"
86243	Black	43	17	33"-35"
86244	Black	44	17 - $\frac{1}{2}$	33"-35"
86245	Black	45	17 - $\frac{3}{4}$	33"-35"
86246	Black	46	18	33"-35"
86247	Black	47	18 - $\frac{1}{2}$	33"-35"
86248	Black	48	19	33"-35"
86249	Black	49	19 - $\frac{1}{2}$	33"-35"
86250	Black	50	20	33"-35"
86252	Black	52	20 - $\frac{1}{2}$	33"-35"

Torino #863

65% polyester and 35% cotton

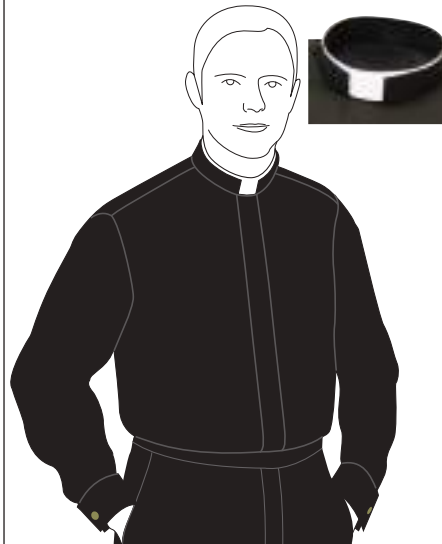

Ref.	Colour	Size Euro	Size US	Sleeve length us
86338	Black	38	15	35"-37"
86339	Black	39	15 - $\frac{1}{2}$	35"-37"
86340	Black	40	15 - $\frac{3}{4}$	35"-37"
86341	Black	41	16	35"-37"
86342	Black	42	16 - $\frac{1}{2}$	35"-37"
86343	Black	43	17	35"-37"
86344	Black	44	17 - $\frac{1}{2}$	35"-37"
86345	Black	45	17 - $\frac{3}{4}$	35"-37"
86346	Black	46	18	35"-37"
86347	Black	47	18 - $\frac{1}{2}$	35"-37"
86348	Black	48	19	35"-37"
86349	Black	49	19 - $\frac{1}{2}$	33"-35"
86350	Black	50	20	35"-37"
86352	Black	52	20 - $\frac{1}{2}$	35"-37"

Sales tools

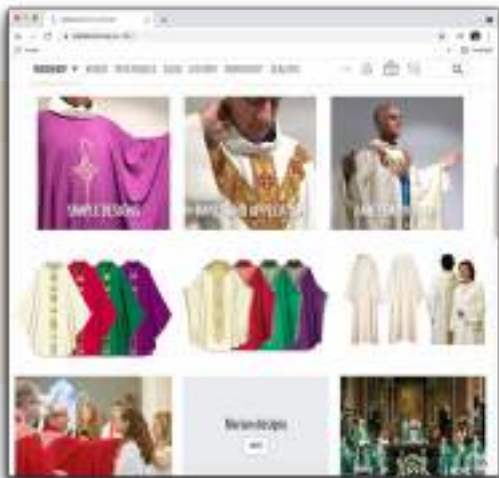

Apart from the public website, our website offers several services for the dealers:

- **online order tracking** : use your dealernumber and your own PO number. You can also share this information with your customers.
- **online altar cloth price calculator**
- **www.createyourchasuble.com** : an interactive website and app to create your own Slabbinck vestment.

Swatch cards



Small cards with fabric samples attached, very handy when you want to send some samples to your customers. Swatch cards are available for all our fabrics at no charge. Swatch cards are available throughout the year, but are not shipped automatically, you have to order them.



Catalogue

Can be personalised, ask for prices.



Viktor



Mirabel



Jeroen



Hannah



Annabel



Rita



Fleur



Greta



Olga



Rien



Peter



Danielle



Ellemieke



Lut

